

Zahnmedizin
Zahntechnik

Dentistry/Dental Technique
Odontologie/Prothese Dentaire
Odontologia/Protesis Dental

2020-2021



Diamant • Polierer • Schleifkörper

Diamond/Polishers/Abrasives • Diamant/Polissoirs/Abrasifs • Diamante/Pulidores/Abrasivos



Christian Rothe

Gert Busch

There is no substitute for quality

„Qualität hat keine Alternative“ – diese Überzeugung prägt seit Gründung unseres Unternehmens im Jahre 1905 unsere Unternehmensphilosophie.

Unsere Ideen und alle Prozesse der Entwicklung, Produktion und des Vertriebs folgen dieser Philosophie.

„There is no substitute for quality“ this conviction has committed our company's philosophy since our foundation in 1905.

Our ideas and all processes of research & development, production and distribution meet with the demands of this philosophy.

„Il n'y a pas d'alternative à la qualité“ c'est bien notre conviction depuis la création de la société Busch en 1905.

Nos idées ainsi que tous les processus du développement, de la production et de la vente correspondent à cette philosophie.

„Calidad no tiene alternativa“ – Esta convicción caracteriza nuestra filosofía desde la fundación en 1905.

Nuestras ideas y todos los procesos en el desarrollo, en la producción y en la distribución siguen esta filosofía.

Inhalt Index Index Indice

Zahnmedizin • Dentistry
Odontologie • Odontologia

Diamant

Diamond • Diamant • Diamante 4-35



Polierer

Polishers • Polissoirs • Pulidores 36-47



Schleifkörper

Abrasives • Abrasifs • Abrasivos 48-51



Zahntechnik • Dental Technique
Prothese Dentaire • Protesis Dental

Diamant

Diamond • Diamant • Diamante 52-69



Polierer

Polishers • Polissoirs • Pulidores 70-81



Schleifkörper

Abrasives • Abrasifs • Abrasivos 82-93



Sonstiges

Miscellaneous • Autres • Otros

94-101



Basisinformationen

Basic information • Informations de base • Informaciones básicas

102-115



Bestellnummern

Product codes • Numéros références • Referencias de los instrumentos

116-118

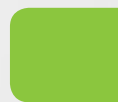

Diamant

Diamond • Diamant • Diamante















Zahnmedizin

Dentistry • Odontologie • Odontologia

Anwendungsbeispiele Examples of application Exemples d'application Ejemplos de aplicaciones	6-7
COOL DIAMANT	8-13
Premium Diamantschleifer Premium diamond instruments Instruments diamantés supérieurs Instrumentos diamantados superiores	14-31
Micro Prep Instrumente Micro Prep instruments Instruments Micro Prep Instrumentos Micro Prep	32+33
Ziramant Instrumente Ziramant instruments Instruments ziramant Instrumentos ziramant	34
Dia PERIO-PRO Instrumente Dia PERIO-PRO instruments Instruments Dia PERIO-PRO Instrumentos Dia PERIO-PRO	35

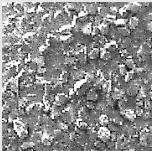

Einsatzgebiet application area domaine d'application uso en sector	Arbeitsgang working process phase de travail fase de trabajo	Körnung R.E.M. (30x) grit D.S.M. (30x) grain M.E.B. (30x) grano M.E.R. (30x)	Instrumentenbeispiel examples of instr. exempl. d'instruments ej. de los instrumentos	ISO-Ø	empf. Drehzahl min ⁻¹ recommended speed vit. de rotation rec. veloc. recomendada
Schmelz, Dentin enamel, dentine email, dentine esmalte, dentina	Zügiges Vorschleifen faster pregrinding dégrossissage rapide rectificado inicial rápido		5831/014 	012 – 023	225.000 – 60.000
Schmelz, Dentin enamel, dentine email, dentine esmalte, dentina	vorschleifen pregrinding dégrossissage rectificado inicial		CD72G/014 	010 – 023	225.000 – 60.000
			6831/014 		
Schmelz, Dentin enamel, dentine email, dentine esmalte, dentina	Formschleifen shape grinding façonnage rectificado de forma		CD34/012 	010 – 023	225.000 – 60.000
Schmelz, Dentin, Füllungen enamel, dentine, fillings email, dentine, obturations esmalte, dentina, obturaciones			CD80/014 		
Schmelz, Dentin enamel, dentine email, dentine esmalte, dentina			831/012 		
Schmelz, Dentin, Füllungen enamel, dentine, fillings email, dentine, obturations esmalte, dentina, obturaciones			859/010 	008 – 055	225.000 – 35.000
Schmelz, Dentin, Füllungen enamel, dentine, fillings email, dentine, obturations esmalte, dentina, obturaciones	Feinschleifen fine grinding abrasion de précision rectificado fino		CD72F/014 	007 – 031	100.000 – 20.000
			8801/023 		

Einsatzgebiet application area domaine d'application uso en sector	Arbeitsgang working process phase de travail fase de trabajo	Körnung R.E.M. (30x) grit D.S.M. (30x) grain M.E.B. (30x) grano M.E.R. (30x)	Instrumentenbeispiel examples of instr. exempl. d'instruments ej. de los instrumentos	ISO-Ø	empf. Drehzahl min ⁻¹ recommended speed vit. de rotation rec. veloc. recomendada
---	---	---	--	-------	--

Schmelz, Dentin, Füllungen enamel, dentine, fillings email, dentine, obturations esmalte, dentina, obturaciones	Finieren finishing finissage acabado		862EF/012 	007 – 029	100.000 – 20.000
Schmelz, Dentin (für Ceramic Inlays) enamel, dentine (for ceramic inlays) email, dentine (pour inlays en céramique) esmalte, dentina (para ceramic inlays)			CI847EF/018 		

Dia PERIO-PRO

Zahnstein calculus plaque dentaire cálculo	Entfernen removal retrait retracción		8406LF/012 	012	12.000
Wurzelzement root cementum ciment radiculaire cemento de raices	Glätten polishing lissage alisado		8407LEF/012 	012	8.000

Micro Prep

Schmelz, Dentin enamel, dentine email, dentine esmalte, dentina	minimal invasiv minimum contact invasive minimale invasiva minimal		MI806 	007 – 014	150.000 – 120.000
			MI8806 	007 – 014	120.000 – 100.000

ZIRAMANT

Zirkonoxid zirconia oxyde de zirconium óxido de zirconio	Trepanieren/Entfernen trepanation/removal trépanation/retrait trepanación/retracción		6880Z/014 	010 – 018	
	Korrektur von Abutments correction of abutments correction de piliers retoque de pilares		862Z/016 	014 – 016	160.000 – 140.000
	Feinkorrektur fine correction correction de précision retoques precisos		8838LZ/009 	009 – 011	

COOL DIAMANT



cool

Die Oberfläche der COOL DIAMANT-Schleifer ist durch asymmetrisch sich kreuzende Kanäle unterbrochen. Diese diamantierten Kanäle können zum einen eine erhöhte Menge Kühlflüssigkeit transportieren und unterbrechen zum anderen den Schleifvorgang bis zu 7 mal bei jeder Umdrehung des Schleifers. Beides fördert einen kühlen Schliff.

Asymmetrically intersecting grooves break up the surface of the COOL DIAMANT instruments. These diamond-coated grooves not only transport more cooling medium, but also interrupt the grinding process up to seven times during each rotation of the instrument. These two factors ensure a cool process.

La surface des instruments COOL DIAMANT est sillonnée de canaux qui se croisent selon une structure asymétrique. Ces canaux diamantés sont capables non seulement d'évacuer une quantité plus importante de liquide de refroidissement, mais aussi d'interrompre le meulage jusqu'à sept fois par rotation, deux atouts qui garantissent une abrasion "cool".

La superficie de los instrumentos COOL DIAMANT está demarcada por canales que se cruzan de forma asimétrica. Estos canales diamantados pueden transportar una cantidad de líquido refrigerante relativamente elevada y al mismo tiempo interrumpen el proceso de pulido hasta 7 veces en cada vuelta del instrumento. Ambas características aseguran un pulido "cool".

schnell

**fast
gain de temps
rápido**

Bei umfangreichen prothetischen Präparationsaufgaben ergaben sich bei Einsatz von COOL DIAMANT-Schleifern bereits mit mittlerer Körnung deutliche Zeiteinsparungen. Die original COOL DIAMANT-Schleifer sind zur schnelleren Identifikation in allen drei Körnungen golden.

Extensive prosthetic preparations using COOL DIAMANT instruments in medium grit, turn out to show a considerable saving in time. The original COOL DIAMANT instruments are golden in all three grits for a faster identification.

Pour les préparations prothétiques importantes l'utilisation des COOL DIAMANT grain moyen apporte un gain de temps. Pour une identification rapide, les originaux COOL DIAMANT en 3 différents grains sont tous dorés.

Utilizando instrumentos diamantados COOL DIAMANT de grano medio en numerosas preparaciones protéticas, se han logrado ahorros de tiempo significante. Los instrumentos diamantados originales COOL DIAMANT son dorados en los tres tamaños de grano, para una identificación más rápida.

wirtschaftlich

**economical
économique
económico**

Der hochwertige Diamantbelag mit Panzerschutzschicht, die gleichmäßige stabilitätserhöhende Diamantierung auch in den Kanälen und ständige Fertigungskontrollen garantieren die überlegene BUSCH-Qualität. Der reduzierte Zeitbedarf sowie die Langlebigkeit der COOL DIAMANT-Schleifer ermöglichen wirtschaftliche und zugleich patientenfreundliche Präparationen.

The high-grade diamond coating with armour-protective layer, the consistent stability of the diamond coating also in the cooling grooves and constant controls guarantee the top-class quality of BUSCH instruments. The time-saving as well as the longevity of the COOL DIAMANT instruments make economical and patient-friendly preparations.

La couche diamantée de haute qualité avec protection, le revêtement diamanté symétrique des rainures de refroidissement offrant une stabilité accrue et les contrôles de fabrication constants garantissent la qualité supérieure BUSCH. Le gain de temps et la longévité des COOL DIAMANT permettent des préparations économiques et agréables pour les patients.

El recubrimiento diamantado de alta calidad con capa de protección, el diamantado uniforme, que aumenta la estabilidad también en el interior de los canales de refrigeración, y los continuos controles de fabricación garantizan la superior calidad de BUSCH. El ahorro de tiempo necesario así como la larga vida útil de los instrumentos diamantados COOL DIAMANT, permiten realizar preparaciones más económicas y al mismo tiempo más agradables para el paciente.

drei Körnungen

**3 grits
3 grains
3 tamaños de grano**

Funktions- und formkongruente Instrumente in drei Körnungen für präzise aufeinander abgestimmte Präparationsschritte.

Congruent instruments in function and shape in three grits for precise coordinating steps in the preparation.

Les instruments d'une congruence de forme et fonction en 3 grains pour une coordination précise des phases de préparations.

Instrumentos congruentes en función y forma entre granulaciones para precisos pasos de preparaciones coordinados.

Instrumentos congruentes en función y forma, en tres tamaños de grano, para fases de preparación exactamente adaptadas.

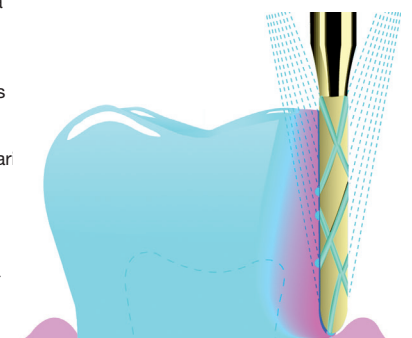

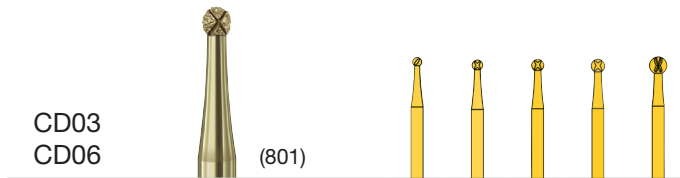

INFO

Sonderprospekt anfordern!
Please ask for our special leaflet!
Demandez notre prospectus spécial!
Pidan Vdes. nuestro folleto especial!





	FG	CD03/...	012				
	FG	CD06/...		014	016	018	023







	FG	CD09/...	012			
	FG	CD12/...		016	018	
	FG	CD15/...				016
	L mm		1,5	1,7	1,8	4,0



	● FG	CD18G/...	012		
	FG	CD18/...	012	014	016
	L mm		2,7	2,7	2,7



	● FG	CD19G/...	014	016	
	FG	CD19/...	014	016	018
	L mm		5,0	5,0	5,0

● grobe Körnung, coarse grit, gros grain, grano grueso } 
 mittlere Körnung, medium grit, grain moyen, grano mediano }
 ● feine Körnung, fine grit, grain fin, grano fino } 

CD63 (876)

● FG

FG	CD63/...	010
L mm		5,0

● CD66G
CD66
● CD66F (877)

● FG

● FG	CD66G/...	010		
FG	CD66/...	010	012	014
● FG	CD66F/...	010		
L mm		6,0	6,0	6,0

● CD69G
CD69
● CD69F (878)

● FG

● FG	CD69G/...	012	014	016
FG	CD69/...	012	014	016
● FG	CD69F/...		014	
L mm		8,0	8,0	8,0

● CD72G
CD72
● CD72F (879)

● FG

● FG	CD72G/...	012*	014	016
FG	CD72/...	012*	014	016
● FG	CD72F/...	012*	014	016
L mm		10,0	10,0	10,0

*Drehzahlempfehlung/recommended speed/vitesse recommandée/velocidad recomendada
CD72, CD72G, CD72F 012 110.000-150.000 min⁻¹/rp.m.

● CD27G
CD27

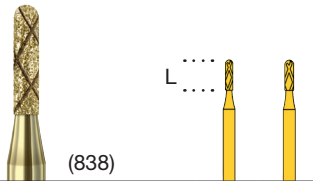

CD27 auch als Komposite-Entferner geeignet
 CD27 also suitable for removal of composite
 CD27 aussi adapté pour le retrait des composites
 CD27 adecuado para la retirada de composite



● FG	CD27G/...	010		
FG	CD27/...	010	012	
L mm		4,0	4,0	

● CD33G
CD33
● CD33F

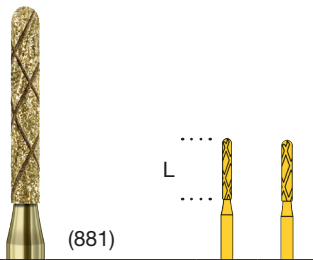

● FG	CD33G/...	012	014	
FG	CD33/...	012	014	
● FG	CD33F/...	012		
L mm		8,0	8,0	

● CD21G
CD21

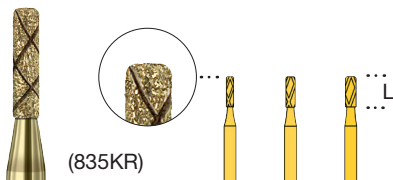

● FG	CD21G/...	010	012	014
FG	CD21/...	010	012	014
L mm		4,0	4,0	4,0

● CD25G
CD25

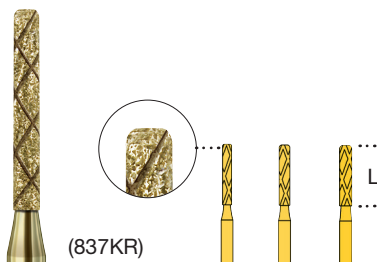

● FG	CD25G/...	012	014	
FG	CD25/...	012	014	016
L mm		8,0	8,0	8,0

● CD30G
CD30

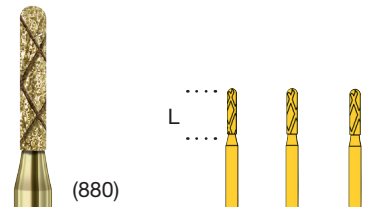

● FG	CD30G/...		012	014
FG	CD30/...	010	012	014
L mm		6,0	6,0	6,0

● CD34G
CD34

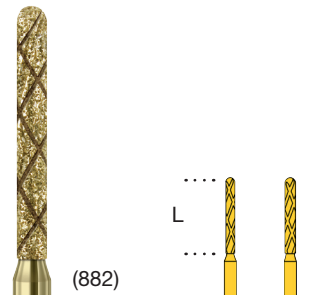

● FG	CD34G/...	012*	014	
FG	CD34/...	012*	014	
L mm		10,0	10,0	

*Drehzahlmpfehlung/recommended speed/vitesse recommandée/velocidad recomendada
 CD34, CD34G 012 110.000-150.000 min⁻¹/r.p.m.

● CD24G
CD24

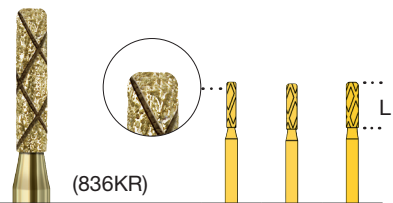

● FG	CD24G/...	012	014	
FG	CD24/...	012	014	016
L mm		6,0	6,0	6,0

● grobe Körnung, coarse grit, gros grain, grano grueso }
 mittlere Körnung, medium grit, grain moyen, grano mediano }
 ● feine Körnung, fine grit, grain fin, grano fino }

CD36 (845KR)

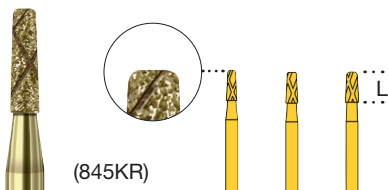

FG

CD36/...	014	016	018
L mm	4,0	4,0	4,0

CD37 (846KR)

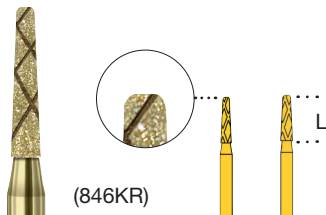

FG

CD37/...	014	016
L mm	6,0	6,0

● CD39G
CD39 (847KR)

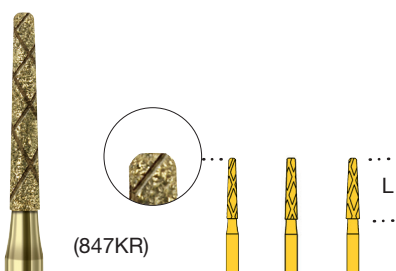

FG

CD39G/...		016		
FG	CD39/...	014	016	018
L mm		8,0	8,0	8,0

● CD42G
CD42 (848KR)

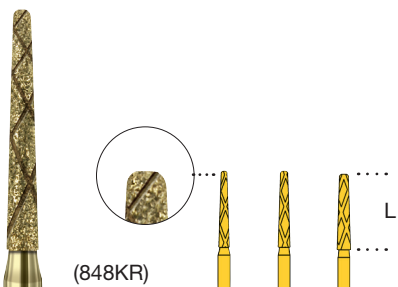

FG

CD42G/...		016	018	
FG	CD42/...	014	016	018
L mm		10,0	10,0	10,0

CD45 (855)



FG

CD45/...	014
L mm	6,0

● CD48G
CD48 (856)

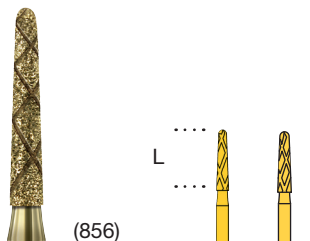

FG

CD48G/...	016	018	
FG	CD48/...	016	
L mm		8,0	8,0

● CD51G
CD51 (850)

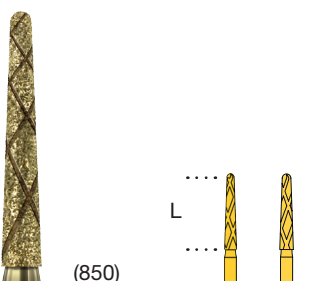

FG

CD51G/...	016	018	
FG	CD51/...	016	018
L mm		10,0	10,0

● grobe Körnung, coarse grit, gros grain, grano grueso }
 mittlere Körnung, medium grit, grain moyen, grano mediano }
 ● feine Körnung, fine grit, grain fin, grano fino }



● CD54G
CD54

(858)



	CD54G/...	014
● FG	CD54/...	014
L mm		8,0

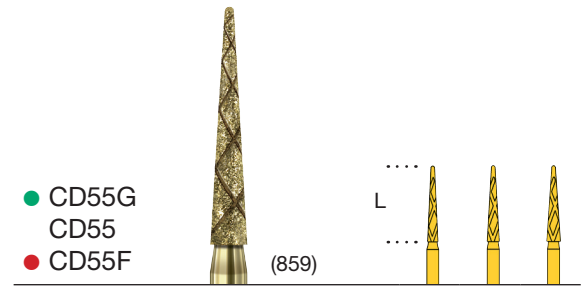

● CD55G
CD55
● CD55F

(859)

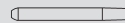

	CD55G/...	014	016	018
● FG	CD55/...	014	016	018
● FG	CD55F/...	014		
L mm		10,0	10,0	10,0



CD57

(860)



	CD57/...	012	016
FG			
L mm		5,0	5,0



● CD60G
CD60
● CD60F

(862)

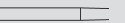

	CD60G/...		014	
● FG	CD60/...	012	014	016
● FG	CD60F/...	012		016
L mm		8,0	8,0	8,0

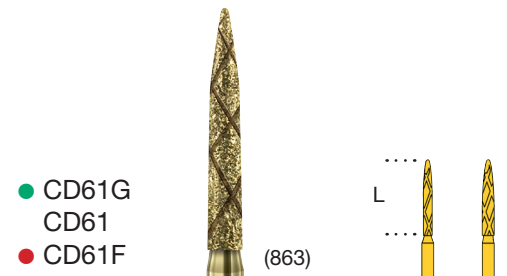

● CD61G
CD61
● CD61F

(863)



	CD61G/...	012	016
● FG	CD61/...	012	016
● FG	CD61F/...	012	016
L mm		10,0	10,0



● CD80G
CD80
● CD80F

(368)



	CD80G/...		023
● FG	CD80/...	016	023
● FG	CD80F/...		023
L mm		3,5	5,0

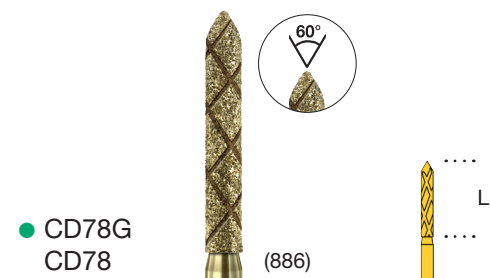



● CD78G
CD78

(886)



	CD78G/...	016
● FG	CD78/...	016
L mm		10,0

● grobe Körnung, coarse grit, gros grain, grano grueso } 
 mittlere Körnung, medium grit, grain moyen, grano mediano } 
 ● feine Körnung, fine grit, grain fin, grano fino } 

Premium Diamantschleifer

Premium diamond instruments • Instruments diamantés supérieurs • Instrumentos diamantados superiores



Premium Diamantschleifer

Für Ihre anspruchsvolle Patienten-Behandlung.

Mit unseren Premium Diamantschleifern sichern Sie sich höchste Präzision, Effektivität und Leistungsstärke. Modernste Fertigungsanlagen und beste Materialien schaffen diesen hohen Qualitäts-Standard. Produktsicherheit für alle vorkommenden Präparations-schritte.

Premium diamond instruments

For your challenging tasks in patient treatment.

With our premium diamond instruments, you can enjoy utmost precision, effectiveness and performance. An outstanding quality like this can only be achieved with the most advanced production facilities and the finest materials.

Instruments diamantés supérieurs

Pour offrir le meilleur traitement à vos patients.





Avec les instruments diamantés premium, vous êtes certain d'avoir ce qu'il y a de mieux en termes de précision, d'efficacité et de performances. Un standard de qualité obtenu grâce à des équipements de fabrication ultramodernes et à des matériaux de qualité supérieure. Un produit qui offre une sécurité absolue pour toutes les étapes de la préparation.

Instrumentos diamantados superiores

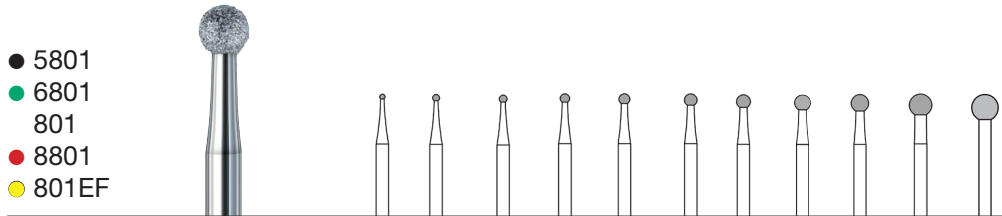
Para el tratamiento de pacientes exigentes.

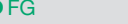
Con los instrumentos diamantados premium se asegura la máxima precisión, efectividad y productividad. Este elevado estándar de calidad se debe a las más modernas instalaciones de fabricación y los mejores materiales. Seguridad de producto para todos los posibles pasos de preparación.

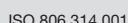

 ● FG ISO 806 314 001 544...	5801/...					014	016	018		023		
 ● FG ISO 806 314 001 534...	6801/...			010	012	014	016	018	021	023	029	
 FG ISO 806 314 001 524...	801/...		009	010	012 ***	014 ***	016 ***	018 ***	021	023 ***	029	035
 ● FG ISO 806 314 001 514...	8801/...	007				014	016	018		023	029	035
 ● FG ISO 806 314 001 504...	801EF/...	007				014		018		023	029	
 W/RA/CA ISO 806 204 001 524...	801/...									023		



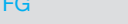

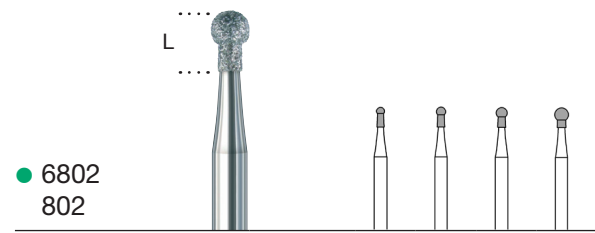
 ● FG ISO 806 314 697 534...	6801L/...	016
 FG ISO 806 314 697 524...	801L/...	016

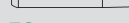
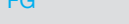

 ● FG ISO 806 314 002 534...	6802/...	010	012	014	
 FG ISO 806 314 002 524...	802/...	010	012	014	018
L mm		2,6	2,6	2,6	2,6

*** auch als COOL-Diamant-Schleifer lieferbar (siehe Seiten 9-13)
 also available as COOL-Diamond Instruments (see pages 9-13)
 Egalement disponible en instruments COOL Diamonds (voir pages 9-13)
 También disponible como instrumentos COOL Diamonds (ver las páginas 9-13)

● sehr grobe Körnung, very coarse grit, très gros grain, grano muy grueso } 
 ● grobe Körnung, coarse grit, gros grain, grano grueso }
 ● mittlere Körnung, medium grit, grain moyen, grano mediano }
 ● feine Körnung, fine grit, grain fin, grano fino } 
 ● extra feine Körnung, extra fine grit, grain extra fin, grano extra fino }

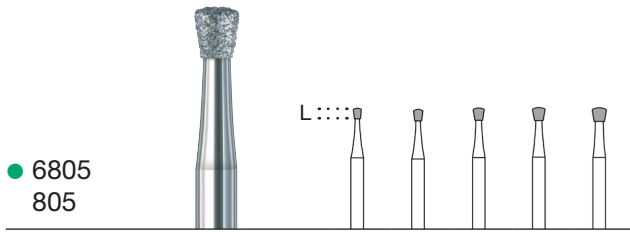

	6805/...	012	014	016		
● FG	ISO 806 314 010 534...					
FG	805/...	010	012	014	016	018
	ISO 806 314 010 524...	***	***	***	***	***
L mm		1,4	1,5	1,6	1,7	1,8

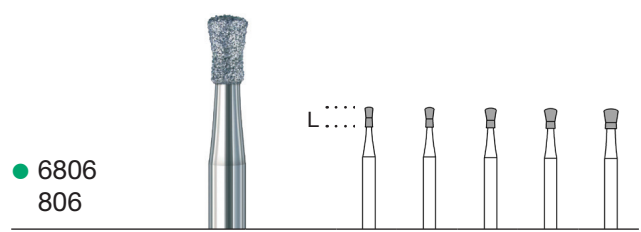

	6806/...	012	014	016		
● FG	ISO 806 314 019 534...					
FG	806/...	010	012	014	016	018
	ISO 806 314 019 524...					
L mm		2,6	2,6	2,6	2,6	2,6



	807/...	012	016
FG	ISO 806 314 225 524...	***	***
L mm		3,5	4,0

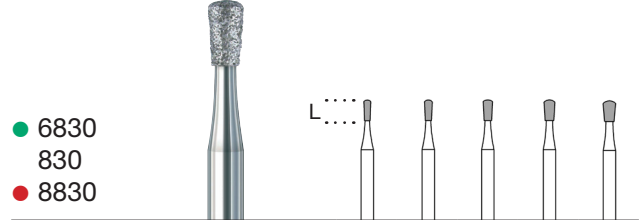

	6830/...	010	012	014	016	
● FG	ISO 806 314 233 534...		***			
FG	830/...	009	010	012	014	016
	ISO 806 314 233 524...		***	***	***	
● FG	8830/...		012	014		
	ISO 806 314 233 514...					
L mm		2,7	2,7	2,7	2,7	2,7

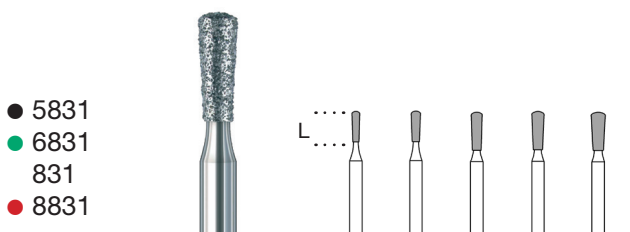





	5831/...		014			
● FG	ISO 806 314 234 544...					
● FG	6831/...	012	014	016	018	
	ISO 806 314 234 534...		***	***		
FG	831/...	010	012	014	016	018
	ISO 806 314 234 524...		***	***	***	
● FG	8831/...	012	014			
	ISO 806 314 234 514...					
L mm		4,0	4,0	5,0	5,0	5,0



	6831R/...	012	014	016	018
● FG	ISO 806 314 238 534...				
FG	831R/...	012	014	016	018
	ISO 806 314 238 524...				
● FG	8831R/...	012		016	
	ISO 806 314 238 514...				
L mm		4,0	5,0	5,0	5,0

*** auch als COOL-Diamant-Schleifer lieferbar (siehe Seiten 9-13)
 also available as COOL-Diamond Instruments (see pages 9-13)
 Egalement disponible en instruments COOL Diamonds (voir pages 9-13)
 También disponible como instrumentos COOL Diamonds (ver las páginas 9-13)

● sehr grobe Körnung, very coarse grit, très gros grain, grano muy grueso } 
 ● grobe Körnung, coarse grit, gros grain, grano grueso } 
 ● mittlere Körnung, medium grit, grain moyen, grano mediano } 
 ● feine Körnung, fine grit, grain fin, grano fino } 
 ● extra feine Körnung, extra fine grit, grain extra fin, grano extra fino } 

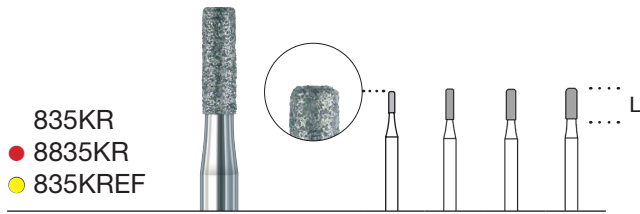

- 835KR
- 8835KR
- 835KREF



	FG	835KR/...	008	010	012	014
		ISO 806 314 156 524..		***	***	***
	● FG	8835KR/...		010	012	
		ISO 806 314 156 514...				
	● FG	835KREF/...			012	
		ISO 806 314 156 504...				
	L mm		3,0	4,0	4,0	4,0

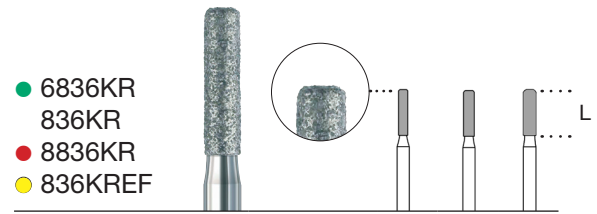

- 6836KR
- 836KR
- 8836KR
- 836KREF



	● FG	6836KR/...	012			
		ISO 806 314 157 534...	***			
	FG	836KR/...	012	014	016	
		ISO 806 314 157 524...	***	***	***	
	● FG	8836KR/...	012	014	016	
		ISO 806 314 157 514...				
	● FG	836KREF/...	012			
		ISO 806 314 157 504...				
	L mm		6,0	6,0	6,0	

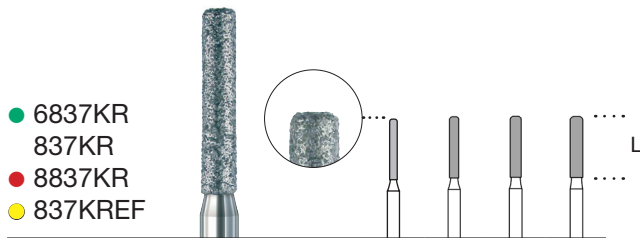

- 6837KR
- 837KR
- 8837KR
- 837KREF



	● FG	6837KR/...		012	014	
		ISO 806 314 158 534...			***	
	FG	837KR/...	010	012	014	016
		ISO 806 314 158 524...		***	***	***
	● FG	8837KR/...	010	012	014	016
		ISO 806 314 158 514...				
	● FG	837KREF/...			014	
		ISO 806 314 158 504...				
	L mm		8,0	8,0	8,0	8,0



- 837LKR
- 8837LKR



	FG	837LKR/...	012*	014
		ISO 806 314 586 524...		
	● FG	8837LKR/...	012*	014
		ISO 806 314 586 514...		
	L mm		10,0	10,0

* Drehzahlempfehlung/recommended speed/vitesse recommandée/velocidad recomendada
 837LKR, 8837LKR 012 110.000-150.000 min⁻¹/r.p.m.



842KR



	FG	842KR/...	014*
		ISO 806 314 112 524...	
	L mm		12,0

* Drehzahlempfehlung/recommended speed/vitesse recommandée/velocidad recomendada
 842KR 014 110.000-150.000 min⁻¹/r.p.m.

*** auch als COOL-Diamant-Schleifer lieferbar (siehe Seiten 9-13)
 also available as COOL-Diamond Instruments (see pages 9-13)
 Egalement disponible en instruments COOL Diamonds (voir pages 9-13)
 También disponible como instrumentos COOL Diamonds (ver las páginas 9-13)

● sehr grobe Körnung, very coarse grit, très gros grain, grano muy grueso } 6
 ● grobe Körnung, coarse grit, gros grain, grano grueso }
 ● mittlere Körnung, medium grit, grain moyen, grano mediano }
 ● feine Körnung, fine grit, grain fin, grano fino } 2
 ● extra feine Körnung, extra fine grit, grain extra fin, grano extra fino }



● FG	5836/...	012			
ISO 806 314 110 544...					
● FG	6836/...	012	014	018	
ISO 806 314 110 534...					
FG	836/...	012	014	018	
ISO 806 314 110 524...					
● FG	8836/...	012			
ISO 806 314 110 514...					
L mm		6,0	6,0	6,0	

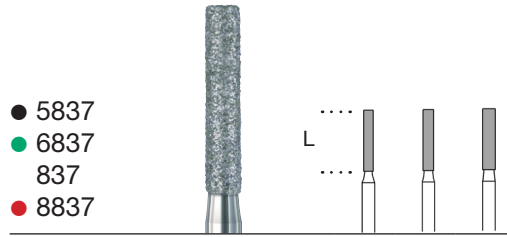

● FG	5837/...		014		
ISO 806 314 111 544...					
● FG	6837/...	012	014	016	
ISO 806 314 111 534...					
FG	837/...	012	014	016	
ISO 806 314 111 524...					
● FG	8837/...		014		
ISO 806 314 111 514...					
L mm		8,0	8,0	8,0	

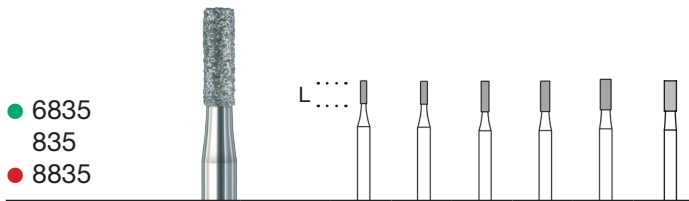

● FG	6835/...		009	010	012	014	
ISO 806 314 107 534...							
FG	835/...	008	009	010	012	014	016
ISO 806 314 107 524...							
● FG	8835/...			010		014	
ISO 806 314 107 514...							
L mm		3,0	3,0	4,0	4,0	4,0	4,0

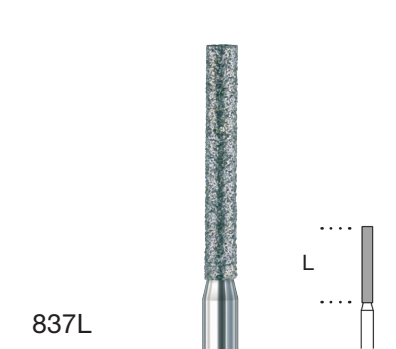

FG	837L/...	014
ISO 806 314 112 524...		
L mm		10,0

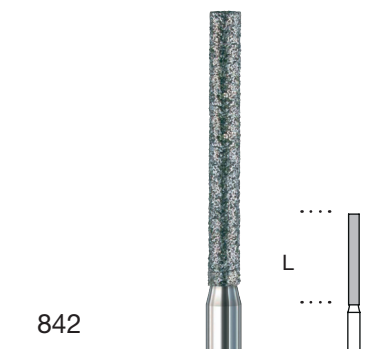

FG	842/...	014*
ISO 806 314 112 524...		
L mm		12,0

*Drehzahlempfehlung/recommended speed/vitesse recommandée/velocidad recomendada 842 014 110.000-150.000 min⁻¹/r.p.m.

- sehr grobe Körnung, very coarse grit, très gros grain, grano muy grueso
- grobe Körnung, coarse grit, gros grain, grano grueso
- mittlere Körnung, medium grit, grain moyen, grano mediano
- feine Körnung, fine grit, grain fin, grano fino
- extra feine Körnung, extra fine grit, grain extra fin, grano extra fino



876
 ● 8876



	FG	876/...	009
	ISO 806 314 287 524...		
	● FG	8876/...	009
	ISO 806 314 287 514...		
	L mm		5,0



● 6877
 877
 ● 8877



	● FG	6877/...	010		
	ISO 806 314 288 534...		***		
	FG	877/...	010	012	014
	ISO 806 314 288 524...		***	***	***
	● FG	8877/...	010	012	014
	ISO 806 314 288 514...		***		
	L mm		6,0	6,0	6,0



● 5878
 ● 6878
 878
 ● 8878
 ● 878EF



	● FG	5878/...			014	
	ISO 806 314 289 544...					
	● FG	6878/...	010*	012	014	016
	ISO 806 314 289 534...		***	***	***	
	FG	878/...	010*	012	014	016
	ISO 806 314 289 524...		***	***	***	***
	● FG	8878/...	010*	012	014	016
	ISO 806 314 289 514...			***		
	● FG	878EF/...		012	014	
	ISO 806 314 289 504...					
	L mm		8,0	8,0	8,0	8,0

* Drehzahlempfehlung/recommended speed/vitesse recommandée/velocidad recomendada
 878 010 110.000-150.000 min⁻¹/r.p.m. 6878 010 110.000-150.000 min⁻¹/r.p.m.

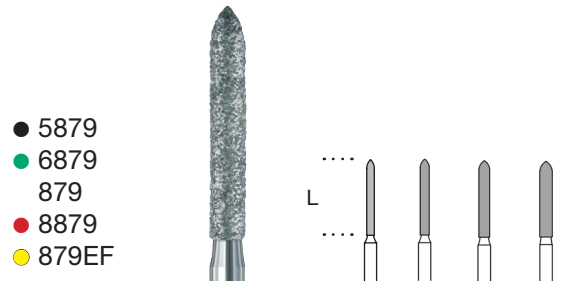

● 5879
 ● 6879
 879
 ● 8879
 ● 879EF



	● FG	5879/...			014	
	ISO 806 314 290 544...					
	● FG	6879/...		012*	014	016
	ISO 806 314 290 534...			***	***	***
	FG	879/...	010*	012*	014	016
	ISO 806 314 290 524...			***	***	***
	● FG	8879/...	010	012	014	016
	ISO 806 314 290 514...			***	***	***
	● FG	879EF/...		012	014	
	ISO 806 314 290 504...					
	L mm		10,0	10,0	10,0	10,0

* Drehzahlempfehlung/recommended speed/vitesse recommandée/velocidad recomendada
 879 010+012 110.000-150.000 min⁻¹/r.p.m. 6879 012 110.000-150.000 min⁻¹/r.p.m.



879L
 ● 8879L



	FG	879L/...	014*
	ISO 806 314 291 524...		
	● FG	8879L/...	014
	ISO 806 314 291 514...		
	L mm		12,0



* Drehzahlempfehlung/recommended speed/vitesse recommandée/velocidad recomendada
 879L 014 110.000-150.000 min⁻¹/r.p.m.

*** auch als COOL-Diamant-Schleifer lieferbar (siehe Seiten 9-13)
 also available as COOL-Diamond Instruments (see pages 9-13)
 Egalement disponible en instruments COOL Diamonds (voir pages 9-13)
 También disponible como instrumentos COOL Diamonds (ver las páginas 9-13)

● sehr grobe Körnung, very coarse grit, très gros grain, grano muy grueso
 ● grobe Körnung, coarse grit, gros grain, grano grueso
 ● mittlere Körnung, medium grit, grain moyen, grano mediano
 ● feine Körnung, fine grit, grain fin, grano fino
 ● extra feine Körnung, extra fine grit, grain extra fin, grano extra fino

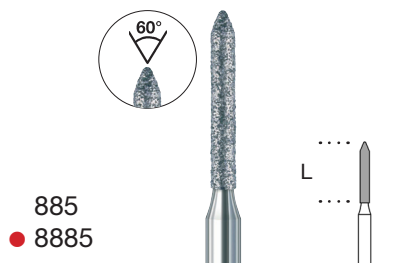



			
	FG	885/...	012
	ISO 806 314 130 524...		
	L mm		8,0

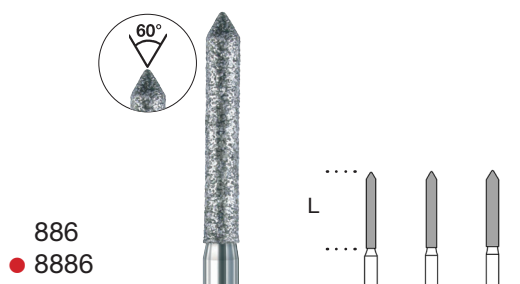

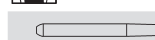
				
	FG	886/...	012*	014
	ISO 806 314 131 524...			016

	● FG	8886/...	014	016
	ISO 806 314 131 514...			
	L mm		10,0	10,0

*Drehzahlempfehlung/recommended speed/vitesse recommandée/velocidad recomendada
 886 012 110.000-150.000 min⁻¹/r.p.m.

*** auch als COOL-Diamant-Schleifer lieferbar (siehe Seiten 9-13)
 also available as COOL-Diamond Instruments (see pages 9-13)
 Egalement disponible en instruments COOL Diamonds (voir pages 9-13)
 También disponible como instrumentos COOL Diamonds (ver las páginas 9-13)

- sehr grobe Körnung, very coarse grit, très gros grain, grano muy grueso
- grobe Körnung, coarse grit, gros grain, grano grueso
- mittlere Körnung, medium grit, grain moyen, grano mediano
- feine Körnung, fine grit, grain fin, grano fino
- extra feine Körnung, extra fine grit, grain extra fin, grano extra fino

- 6838
- 838
- 8838

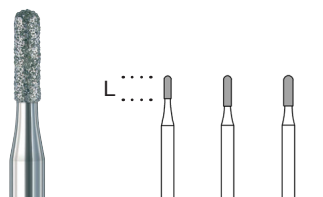

	6838/...		010	012
● FG ISO 806 314 137 534...				
FG ISO 806 314 137 524...	838/...	008	010 ***	012 ***
● FG ISO 806 314 137 514...	8838/...			012
L mm		3,0	4,0	4,0

- 6880
- 880
- 8880

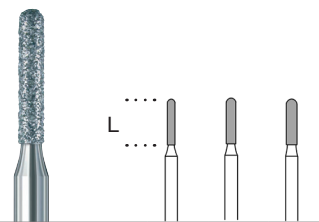

	6880/...		012	014
● FG ISO 806 314 140 534...			***	***
FG ISO 806 314 140 524...	880/...	010 ***	012 ***	014 ***
● FG ISO 806 314 140 514...	8880/...		012	014
L mm		6,0	6,0	6,0

- 5881
- 6881
- 881
- 8881
- 881EF

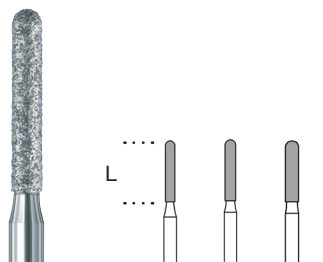

	5881/...		014	
● FG ISO 806 314 141 544...				
● FG ISO 806 314 141 534...	6881/...	012 ***	014 ***	016
FG ISO 806 314 141 524...	881/...	012 ***	014 ***	016
● FG ISO 806 314 141 514...	8881/...	012 ***	014	016
● FG ISO 806 314 141 504...	881EF/...	012		
L mm		8,0	8,0	8,0

- 6882
- 882
- 8882

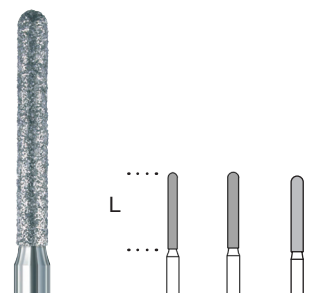



	6882/...		014	
● FG ISO 806 314 142 534...			***	
FG ISO 806 314 142 524...	882/...	012* ***	014 ***	
● FG ISO 806 314 142 514...	8882/...	012	014	016
L mm		10,0	10,0	10,0

*Drehzahlempfehlung/recommended speed/vitesse recommandée/velocidad recomendada
 882 012 110.000-150.000 min⁻¹/r.p.m.

*** auch als COOL-Diamant-Schleifer lieferbar (siehe Seiten 9-13)
 also available as COOL-Diamond Instruments (see pages 9-13)
 Egalement disponible en instruments COOL Diamonds (voir pages 9-13)
 También disponible como instrumentos COOL Diamonds (ver las páginas 9-13)

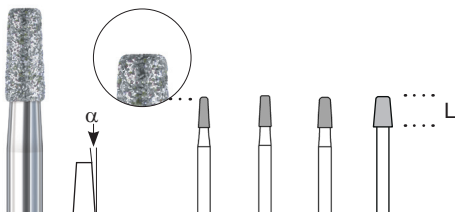

● sehr grobe Körnung, very coarse grit, très gros grain, grano muy grueso }
 ● grobe Körnung, coarse grit, gros grain, grano grueso }
 ● mittlere Körnung, medium grit, grain moyen, grano mediano }
 ● feine Körnung, fine grit, grain fin, grano fino }
 ● extra feine Körnung, extra fine grit, grain extra fin, grano extra fino }

845KR
 ● 8845KR
 ● 845KREF

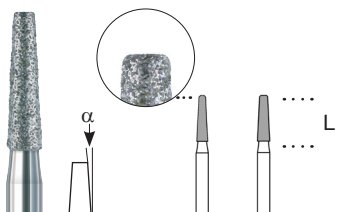

FG ISO 806 314 544 524...	845KR/...		016 ***	018 ***	025
● FG ISO 806 314 544 514...	8845KR/...	014	016	018	025
● FG ISO 806 314 544 504...	845KREF/...		016		
L mm		4,0	4,0	4,0	4,0
α		3°	3°	3°	5°

846KR
 ● 8846KR
 ● 846KREF

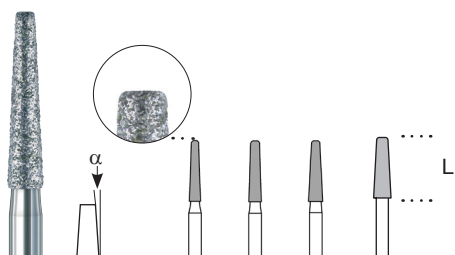

FG ISO 806 314 545 524...	846KR/...		014 ***	016 ***	
● FG ISO 806 314 545 514...	8846KR/...		014	016	
● FG ISO 806 314 545 504...	846KREF/...			016	
L mm			6,0	6,0	
α			3°	3°	

● 6847KR
 847KR
 ● 8847KR
 ● 847KREF

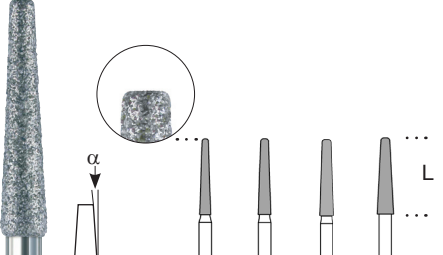

● FG ISO 806 314 546 534...	6847KR/...			018	
FG ISO 806 314 546 524...	847KR/...		014 ***	016 ***	018 ***
● FG ISO 806 314 546 514...	8847KR/...	014	016	018	023
● FG ISO 806 314 546 504...	847KREF/...		016		023
L mm		8,0	8,0	8,0	8,0
α		2°	2°	3°	3°

● 6848KR
 848KR
 ● 8848KR

● FG ISO 806 314 553 534...	6848KR/...		016	018	
FG ISO 806 314 553 524...	848KR/...		014 ***	016 ***	018 ***
● FG ISO 806 314 553 514...	8848KR/...	014	016		021
L mm		10,0	10,0	10,0	10,0
α		2°	2°	2°	3°

*** auch als COOL-Diamant-Schleifer lieferbar (siehe Seiten 9-13)
 also available as COOL-Diamond Instruments (see pages 9-13)
 Egalement disponible en instruments COOL Diamonds (voir pages 9-13)
 También disponible como instrumentos COOL Diamonds (ver las páginas 9-13)

● sehr grobe Körnung, very coarse grit, très gros grain, grano muy grueso } 
 ● grobe Körnung, coarse grit, gros grain, grano grueso }
 ● mittlere Körnung, medium grit, grain moyen, grano mediano }
 ● feine Körnung, fine grit, grain fin, grano fino }
 ● extra feine Körnung, extra fine grit, grain extra fin, grano extra fino } 



CI846
 ● CI846EF



			
FG ISO 806 314 545 524...	CI846/...	012	018
● FG ISO 806 314 545 504...	CI846EF/...	012	018
L mm		6,0	6,0
α		1,5°	1,5°

- für Keramik Inlays
- ein Vollwinkel von 3° bietet beste Haftchancen für das Inlay
- for ceramic inlays
- a 3° round angle offers optimal bonding conditions for the inlay
- pour inlays en céramique
- le angle de 3° (angle de 360°) offre les meilleures chances d'adhérence aux inlays
- para ceramic inlays
- el ángulo de 3° (ángulo de 360°) ofrece la mejor adhesión para inlays



CI847
 ● CI847EF



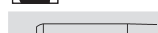

			
FG ISO 806 314 546 524...	CI847/...	018	
● FG ISO 806 314 546 504...	CI847EF/...	018	
L mm		8,0	
α		1,5°	

- sehr grobe Körnung, very coarse grit, très gros grain, grano muy grueso
- grobe Körnung, coarse grit, gros grain, grano grueso
- mittlere Körnung, medium grit, grain moyen, grano mediano
- feine Körnung, fine grit, grain fin, grano fino
- extra feine Körnung, extra fine grit, grain extra fin, grano extra fino



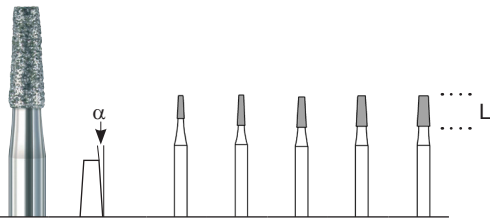

845
● 8845

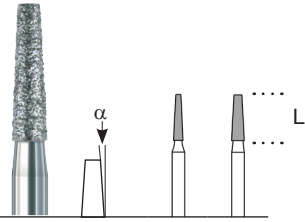

	FG	845/...	009	010	012	014	016
	ISO 806 314 168 524...						
	● FG	8845/...			012		
	ISO 806 314 168 514						
L mm			3,0	4,0	4,0	4,0	4,0
α			3°	3°	3°	3°	3°

6846
846
● 8846

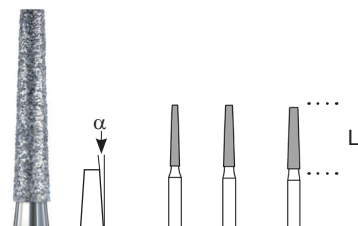

	FG	6846/...			016
	ISO 806 314 171 534...				
	FG	846/...	012	016	
	ISO 806 314 171 524...				
	● FG	8846/...	012		
	ISO 806 314 171 514...				
L mm			6,0	6,0	
α			3°	3°	

6847
847
● 8847



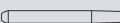

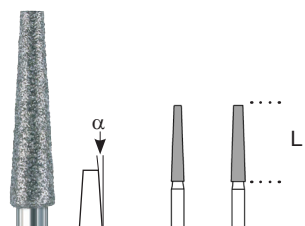
	FG	6847/...	012		016
	ISO 806 314 172 534...				
	FG	847/...	012	014	016
	ISO 806 314 172 524...				
	● FG	8847/...	012		
	ISO 806 314 172 514...				
L mm			8,0	8,0	8,0
α			2°	2°	2°

5848
6848
848
● 8848

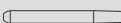



	FG	5848/...	016	
	ISO 806 314 173 544...			
	FG	6848/...	016	018
	ISO 806 314 173 534...			
	FG	848/...	016	018
	ISO 806 314 173 524...			
	● FG	8848/...	016	
	ISO 806 314 173 514...			
L mm			10,0	10,0
α			2°	2°

● sehr grobe Körnung, very coarse grit, très gros grain, grano muy grueso } 
 ● grobe Körnung, coarse grit, gros grain, grano grueso }
 ● mittlere Körnung, medium grit, grain moyen, grano mediano }
 ● feine Körnung, fine grit, grain fin, grano fino } 
 ● extra feine Körnung, extra fine grit, grain extra fin, grano extra fino }

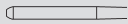

877K
 ● 8877K

	FG	877K/...	014	016
	ISO 806 314 297 524...			
	● FG	8877K/...	014	016
	ISO 806 314 297 514...			
	L mm		6,0	6,0

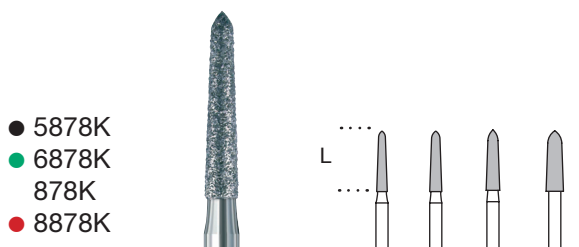

● 5878K
 ● 6878K
 878K
 ● 8878K

	● FG	5878K/...			018	
	ISO 806 314 298 544...					
	● FG	6878K/...	014	016	018	023
	ISO 806 314 298 534...					
	FG	878K/...	014	016		
	ISO 806 314 298 524...					
	● FG	8878K/...	014	016		
	ISO 806 314 298 514...					
	L mm		8,0	8,0	8,0	8,0

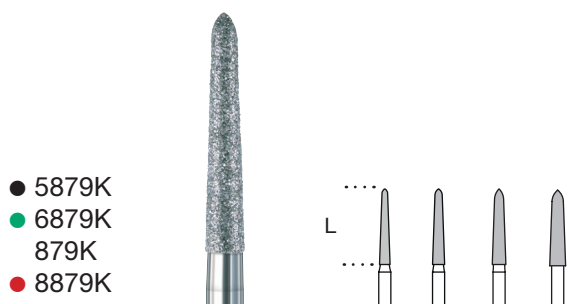

● 5879K
 ● 6879K
 879K
 ● 8879K

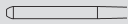
	● FG	5879K/...			018	
	ISO 806 314 299 544...					
	● FG	6879K/...		016	018	021
	ISO 806 314 299 534...					
	FG	879K/...	014	016	018	
	ISO 806 314 299 524...					
	● FG	8879K/...	014	016	018	
	ISO 806 314 299 514...					
	L mm		10,0	10,0	10,0	10,0

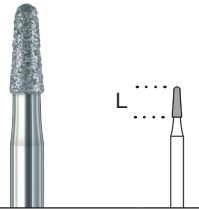

● 8849

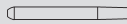

	8849/...	012
● FG	ISO 806 314 194 514...	
L mm		4,0

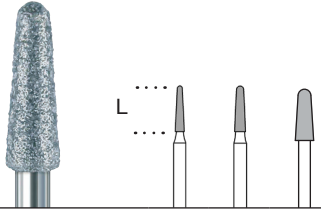

● 6855
855
● 8855

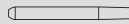

	6855/...	012		025	
● FG	ISO 806 314 197 534...				
FG	ISO 806 314 197 524...	855/...	012	014	025

● FG	ISO 806 314 197 514...	8855/...	012		
L mm			6,0	6,0	7,0

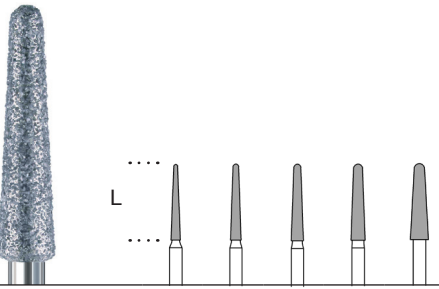

● 5850
● 6850
850
● 8850

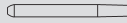

	5850/...			016			
● FG	ISO 806 314 199 544...						
● FG	ISO 806 314 199 534...	6850/...	012	014	016	018	023
				***	***		
FG	ISO 806 314 199 524...	850/...	012	014	016	018	023
				***	***		
● FG	ISO 806 314 199 514...	8850/...	012	014	016		
L mm			10,0	10,0	10,0	10,0	10,0

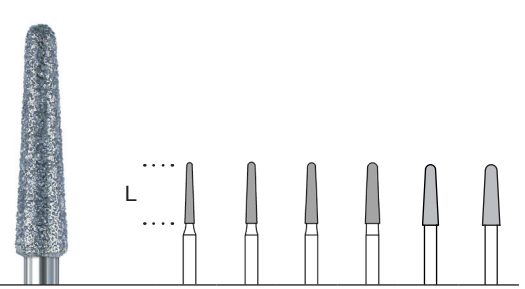



● 5856
● 6856
856
● 8856
● 856EF

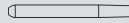

	5856/...		014	016	018			
● FG	ISO 806 314 198 544...							
● FG	ISO 806 314 198 534...	6856/...	012	014	016		021	023

FG	ISO 806 314 198 524...	856/...	012	014	016	018		
				***	***			
● FG	ISO 806 314 198 514...	8856/...	012	014	016	018	021	
● FG	ISO 806 314 198 504...	856EF/...	012		016			
L mm			8,0	8,0	8,0	8,0	8,0	8,0

*** auch als COOL-Diamant-Schleifer lieferbar (siehe Seiten 9-13)
 also available as COOL-Diamond Instruments (see pages 9-13)
 Egalement disponible en instruments COOL Diamonds (voir pages 9-13)
 También disponible como instrumentos COOL Diamonds (ver las páginas 9-13)

● sehr grobe Körnung, very coarse grit, très gros grain, grano muy grueso } 
 ● grobe Körnung, coarse grit, gros grain, grano grueso }
 ● mittlere Körnung, medium grit, grain moyen, grano mediano }
 ● feine Körnung, fine grit, grain fin, grano fino }
 ● extra feine Körnung, extra fine grit, grain extra fin, grano extra fino } 

- 6852
- 852
- 8852
- 852EF

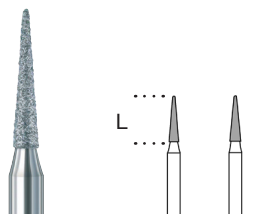

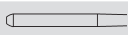
				
● FG	6852/...	012		
ISO 806 314 164 534...				
FG	852/...	012		
ISO 806 314 164 524...				
● FG	8852/...	012		
ISO 806 314 164 514...				
● FG	852EF/...		014	
ISO 806 314 164 504...				
L mm		6,0	6,0	

- 6858
- 858
- 8858
- 858EF

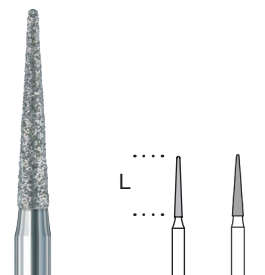

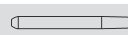

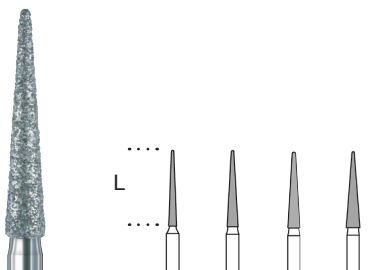

				
● FG	6858/...		014	***
ISO 806 314 165 534...				
FG	858/...	010	014	***
ISO 806 314 165 524...				
● FG	8858/...		014	
ISO 806 314 165 514...				
● FG	858EF/...		014	
ISO 806 314 165 504...				
L mm		8,0	8,0	

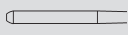
- 6859
- 859
- 8859
- 859EF



					
● FG	6859/...		014		018
ISO 806 314 166 534...			***		***
FG	859/...	010	014	016	018
ISO 806 314 166 524...			***	***	***
● FG	8859/...	010	014		018
ISO 806 314 166 514...			***		
● FG	859EF/...	010	014		018
ISO 806 314 166 504...					
L mm		10,0	10,0	10,0	10,0

*** auch als COOL-Diamant-Schleifer lieferbar (siehe Seiten 9-13)
 also available as COOL-Diamond Instruments (see pages 9-13)
 Egalement disponible en instruments COOL Diamonds (voir pages 9-13)
 También disponible como instrumentos COOL Diamonds (ver las páginas 9-13)

● sehr grobe Körnung, very coarse grit, très gros grain, grano muy grueso } 
 ● grobe Körnung, coarse grit, gros grain, grano grueso } 
 ● mittlere Körnung, medium grit, grain moyen, grano mediano } 
 ● feine Körnung, fine grit, grain fin, grano fino } 
 ● extra feine Körnung, extra fine grit, grain extra fin, grano extra fino } 



860
 ● 8860
 ● 860EF



	FG	860/...	010	012
	ISO 806 314 245 524...			***
● FG	8860/...			012
	ISO 806 314 245 514...			
● FG	860EF/...			012
	ISO 806 314 245 504...			
L mm			4,0	5,0



861
 ● 8861



	FG	861/...	012
	ISO 806 314 248 524...		
● FG	8861/...		012
	ISO 806 314 248 514...		
L mm			6,0

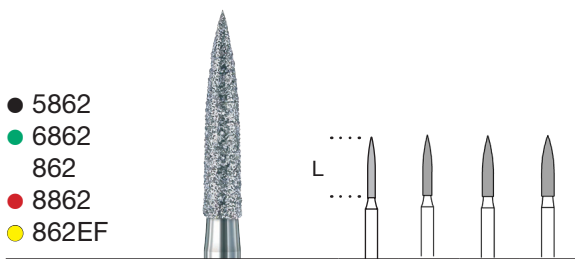

● 5862
 ● 6862
 862
 ● 8862
 ● 862EF



	● FG	5862/...		012		
	ISO 806 314 249 544...					
● FG	6862/...		012	014	016	
	ISO 806 314 249 534...			***	***	
FG	862/...		012	014	016	
	ISO 806 314 249 524...		***	***	***	
● FG	8862/...		012		016	
	ISO 806 314 249 514...		***		***	
● FG	862EF/...	010	012		016	
	ISO 806 314 249 504...					
L mm			8,0	8,0	8,0	8,0



● 5863
 ● 6863
 863
 ● 8863
 ● 863EF



	● FG	5863/...				016
	ISO 806 314 250 544...					
● FG	6863/...		012	014	016	
	ISO 806 314 250 534...		***	***	***	
FG	863/...		012	014	016	
	ISO 806 314 250 524...		***	***	***	
● FG	8863/...	010*	012		016	
	ISO 806 314 250 514...		***		***	
● FG	863EF/...		012		016	
	ISO 806 314 250 504...					
L mm			10,0	10,0	10,0	10,0

*Drehzahlempfehlung/recommended speed/vitesse recommandée/velocidad recomendada
 8863 010 110.000-150.000 min⁻¹/r.p.m.



864
 ● 8864



	FG	864/...	014*
	ISO 806 314 251 524...		
● FG	8864/...		014
	ISO 806 314 251 514...		
L mm			12,0

*Drehzahlempfehlung/recommended speed/vitesse recommandée/velocidad recomendada
 864 014 110.000-150.000 min⁻¹/r.p.m.

*** auch als COOL-Diamant-Schleifer lieferbar (siehe Seiten 9-13)
 also available as COOL-Diamond Instruments (see pages 9-13)
 Egalement disponible en instruments COOL Diamonds (voir pages 9-13)
 También disponible como instrumentos COOL Diamonds (ver las páginas 9-13)

● sehr grobe Körnung, very coarse grit, très gros grain, grano muy grueso
 ● grobe Körnung, coarse grit, gros grain, grano grueso
 ● mittlere Körnung, medium grit, grain moyen, grano mediano
 ● feine Körnung, fine grit, grain fin, grano fino
 ● extra feine Körnung, extra fine grit, grain extra fin, grano extra fino





- 6889
- 8889



● FG	6889/...	009	010
ISO 806 314 540 534...			
● FG	8889/...	009	010
ISO 806 314 540 514...			
L mm		4,0	4,0



- 390
- 8390
- 390EF



FG	390/...	016	018
ISO 806 314 274 524...			
● FG	8390/...	016	018
ISO 806 314 274 514...			
● FG	390EF/...	016	018
ISO 806 314 274 504...			
L mm		3,5	3,7



- 5368
- 6368
- 368
- 8368
- 368EF



● FG	5368/...		023
ISO 806 314 277 544...			
● FG	6368/...	016	023
ISO 806 314 277 534...		***	
FG	368/...	016	023
ISO 806 314 277 524...		***	***
● FG	8368/...	016	023
ISO 806 314 277 514...		***	
● FG	368EF/...	016	023
ISO 806 314 277 504...			
L mm		3,5	5,0



- 5379
- 6379
- 379
- 8379
- 379EF



● FG	5379/...				023
ISO 806 314 277 544...					
● FG	6379/...				023
ISO 806 314 277 534...					
FG	379/...		018		023
ISO 806 314 277 524...					
● FG	8379/...	012	018	021	023
ISO 806 314 277 514...					
● FG	379EF/...		018		023
ISO 806 314 277 504...					
L mm		2,8	3,4	4,2	4,2



- 5811
- 811



● FG	5811/...	033	037
ISO 806 314 277 544...			
FG	811/...	033	
ISO 806 314 038 524...			
FG	811/...		037
ISO 806 314 039 524...			
L mm		4,2	7,0



- 899
- 8899



FG	899/...	021	027	031
ISO 806 314 033 524...				
● FG	8899/...	021	027	031
ISO 806 314 033 514...				
L mm		6,5	7,0	7,0

*** auch als COOL-Diamant-Schleifer lieferbar (siehe Seiten 9-13)
 also available as COOL-Diamond Instruments (see pages 9-13)
 Egalement disponible en instruments COOL Diamonds (voir pages 9-13)
 También disponible como instrumentos COOL Diamonds (ver las páginas 9-13)

● sehr grobe Körnung, very coarse grit, très gros grain, grano muy grueso } 6
 ● grobe Körnung, coarse grit, gros grain, grano grueso } 5
 ● mittlere Körnung, medium grit, grain moyen, grano mediano } 4
 ● feine Körnung, fine grit, grain fin, grano fino } 3
 ● extra feine Körnung, extra fine grit, grain extra fin, grano extra fino } 2

Interdentale Ausarbeitung
 Interproximal trimming
 Elaboration interdentaire
 Elaboración interdental

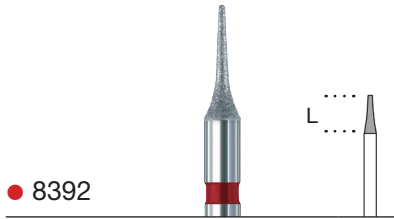

● 8392

	FG	8392/...	016
ISO 806 314 465 514...			
L mm			5,0

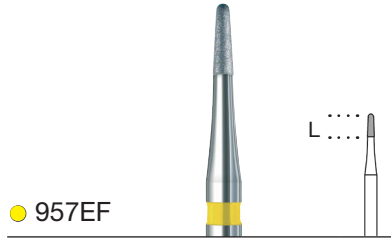

● 957EF



	FG	957EF/...	009
ISO 806 314 195 504...			
L mm			3,0

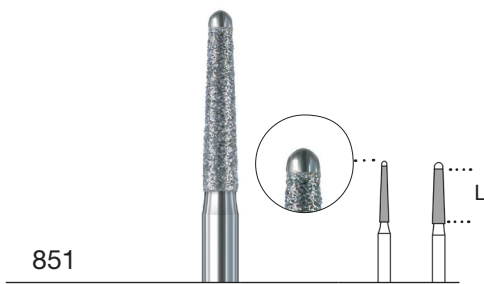

851



	FG	851/...	012	016
ISO 806 314 219 524...				
L mm			8,0	8,0



● 8863GK
 ● 863GKEF



	FG	8863GK/...	012
ISO 806 314 256 514...			
FG	863GKEF/...	012	
ISO 806 314 256 504...			
L mm			10,0



857



	FG	857/...	014
ISO 806 314 220 524...			
L mm			10,5



839



	FG	839/...	012
ISO 806 314 150 524...			

- sehr grobe Körnung, very coarse grit, très gros grain, grano muy grueso
- grobe Körnung, coarse grit, gros grain, grano grueso
- mittlere Körnung, medium grit, grain moyen, grano mediano
- feine Körnung, fine grit, grain fin, grano fino
- extra feine Körnung, extra fine grit, grain extra fin, grano extra fino





		818/...	050
FG	ISO 806 314 041 524...		
L mm		0,7	



● 5909	● 6909	● 909	
● FG	6909/...	040	
ISO 806 314 068 534...			
● FG	6909/...	040	
ISO 806 314 068 534...			
FG	909/...	040	055
ISO 806 314 068 524...			
L mm		1,0	2,0



		813/...	014
FG	ISO 806 314 032 524...		
L mm		1,5	



		833A/...	025
FG	ISO 806 314 219 524...		
L mm		1,5	

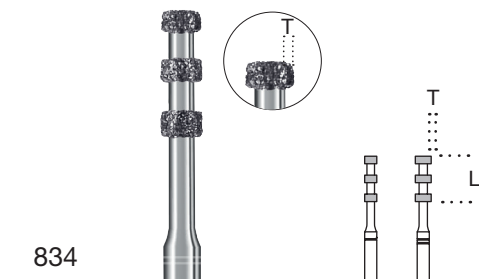

		834/...	016	021
FG	ISO 806 314 219 524...			
L mm		6,0	6,0	
T mm		0,3	0,5	

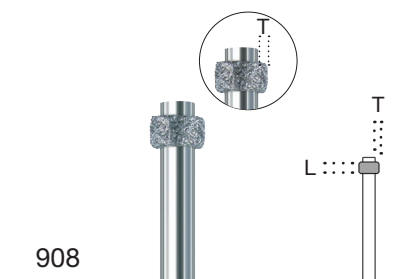

		908/...	026
FG x-lg	ISO 806 316 073 524...		
L mm		1,5	
T mm		0,5	

818/5909/6909/909 =

- sehr grobe Körnung, very coarse grit, très gros grain, grano muy grueso
- grobe Körnung, coarse grit, gros grain, grano grueso
- mittlere Körnung, medium grit, grain moyen, grano mediano
- feine Körnung, fine grit, grain fin, grano fino
- extra feine Körnung, extra fine grit, grain extra fin, grano extra fino

Micro Prep



Minimalinvasive Präparationstechnik

Für das selektive, minimalinvasive Präparieren benötigt man speziell konzipierte Instrumente. Kleinste Arbeitsteildurchmesser, anwendungsorientierte Formen, verschiedene Diamantkorngrößen, lange, schlanke Hälse und ein perfekter Rundlauf sind die wesentlichen Merkmale dieser Instrumente. Die lange, schlanke Halskonstruktion ermöglicht eine perfekte, optische Kontrolle über die Präparation in der Tiefe des Dentins. Selbst an schwer zugänglichen Stellen kann gezielt gearbeitet werden, ohne den Schmelz weit zu öffnen wie das bei gleichen Arbeitsteildurchmessern mit üblicher Halskonstruktion der Fall ist.

Preparation technique based on minimum contact

For a selective, minimal invasive preparation, you need specially designed instruments. The smallest working part diameter, application-oriented shapes, various diamond grit sizes, long, thin necks and a perfect concentric running are the essential characteristics of such instruments. The long thin neck construction allows a perfect optimal control during preparation in the depth of the dentine. Even in hard-to-reach places targeted work can be done without opening the enamel too much, which could be in the case when using the same working part diameters with a normal neck construction.

Préparation invasive minimale

Pour le traitement sélectif, minimalinvasif il faut des instruments spécialement conçus. Les plus petits diamètres des parties travaillantes, les formes adaptées, les différentes tailles de grains, les cols longs et minces et une parfaite concentricité sont les caractéristiques importantes de ces instruments. La construction longue et mince du col permet un parfait contrôle visuel durant le traitement dans la profondeur de la dentine. Ceci permet le traitement précis même aux endroits d'accès difficile sans ouvrir trop l'émail comme c'est le cas avec un instrument d'un diamètre égal avec un col conventionnel.

Técnica de preparación invasiva minimal

Para la preparación selectiva e invasiva mínima, se necesitan instrumentos especialmente concebidos. Pequeños diámetros de las partes activas, formas orientadas a la aplicación, diferentes tamaños de grano diamantado, cuellos largos y delgados y una estabilidad concéntrica perfecta son las principales características de estos instrumentos. La fabricación larga y delgada de los cuellos, permite un control óptico perfecto del trabajo sobre la dentina. Aún así las partes con difícil acceso puedan ser tratadas directamente sin necesidad de abrir el esmalte como es el caso, aplicando instrumentos con los mismos diámetros de las partes de fresado y con los cuellos de tamaño convencional.

INFO

Sonderprospekt anfordern!
Please ask for our special leaflet!
Demandez notre prospectus spécial!
Pidan Vdes. nuestro folleto especial!



MI801



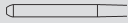

	MI801	010
ISO 806 314 004 524...		



MI802
● **MI8802**

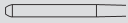



	MI802	014
ISO 806 314 104 524...		
● FG	MI8802	014
ISO 806 314 104 514...		
L mm		2,6



MI806
● **MI8806**

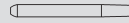



	MI806	014
ISO 806 314 293 524...		
● FG	MI8806	014
ISO 806 314 293 514...		
L mm		2,6



MI830
● **MI8830**

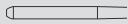

	MI830	009
ISO 806 314 231 524...		
● FG	MI8830	009
ISO 806 314 231 514...		
L mm		2,6



MI830
● **MI8830**

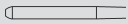

	MI830	012
ISO 806 314 293 524...		
● FG	MI8830	012
ISO 806 314 293 514...		
L mm		2,6

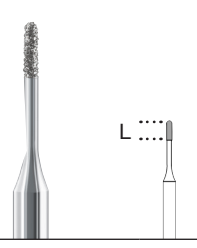

MI838
● **MI8838**



	MI838	007
ISO 806 314 125 524...		
● FG	MI8838	007
ISO 806 314 125 514...		
L mm		2,6

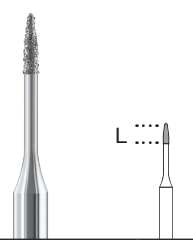

MI889
● **MI8889**



	MI889	007
ISO 806 314 262 524...		
● FG	MI8889	007
ISO 806 314 262 514...		
L mm		2,6

Drehzahlempfehlung/recommended speed/vitesse recommandée/velocidad recomendada

mittlere Körnung/medium grit/grain moyen/grano medio

MI 801 010	140.000 min ⁻¹	MI 830 012	130.000 min ⁻¹
MI 802 014	120.000 min ⁻¹	MI 838 007	150.000 min ⁻¹
MI 806 014	120.000 min ⁻¹	MI 889 007	150.000 min ⁻¹
MI 830 009	140.000 min ⁻¹		

feine Körnung/fine grit/grain fin/grano fino

MI 8802 014	100.000 min ⁻¹	MI 8830 012	100.000 min ⁻¹
MI 8806 014	100.000 min ⁻¹	MI 8838 007	120.000 min ⁻¹
MI 8830 009	110.000 min ⁻¹	MI 8889 007	120.000 min ⁻¹



ZIRAMANT

Spezialdiamantierung für Zirkonoxid/special diamond coating for zirconia

diamantée spéciale pour oxyde de zirconium/recubrimiento diamantado especial para óxido de circonio

Korrektur von Zirkon Abutments
correction of zirconia abutments
correction de piliers de zirconium
retoque de pilares de circonio

Feinkorrektur bei der Zirkon-Inkorporation
fine correction during incorporation of zirconia
correction de précision lors de l'incorporation
de zirconium
retoques precisos durante la incorporación de circonio



- 855Z
- 862Z
- 379Z

- 8801LZ
- 8838LZ



●● FG ISO 806 314 197 525...	855Z/...	014		
●● FG ISO 806 314 249 525...	862Z/...		016	
●● FG ISO 806 314 277 525...	379Z/...			014
L mm		6	8	2,8

●● FG x-lg ISO 806 316 001 515...	8801LZ/...	011		
●● FG x-lg ISO 806 316 137 515...	8838LZ/...			009
L1 mm				2,3
L2 mm		10,8	11,8	

Trepanieren von Zirkonoxid-Restaurationen
trepanation of zirconia restorations
trépanation des restaurations d'oxyde de zirconium
trepanación de óxido de circonio de restauraciones

Entfernen von Zirkonoxid-Restaurationen
removal of zirconia restorations
retrait des restaurations de l'oxyde de zirconium
retracción de óxido de circonio de restauraciones

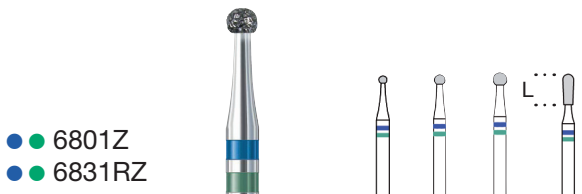

- 6801Z
- 6831RZ

- 6880Z
- 6855Z



●● FG ISO 806 314 001 535...	6801Z/...	010	014	018	-
●● FG ISO 806 314 238 535...	6831RZ/...				014
L mm					4,0

●● FG ISO 806 314 140 535...	6880Z/...	014		
●● FG ISO 806 314 197 535...	6855Z/...			014
L mm		6,0	6,0	

INFO

Sonderprospekt anfordern!
Please ask for our special leaflet!
Demandez notre prospectus spécial!
Pidan Vdes. nuestro folleto especial!

- grobe Körnung, coarse grit, gros grain, grano grueso
- mittlere Körnung, medium grit, grain moyen, grano mediano
- feine Körnung, fine grit, grain fin, grano fino



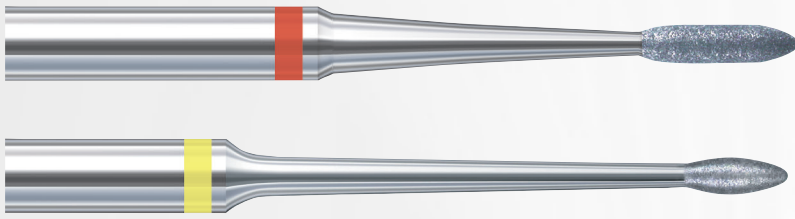

Dia PERIO-PRO

Feine Körnung

- Schonende Beseitigung von supra- und subgingivalem Zahnstein bzw. Konkrementen.
- Odontoplastik (Beseitigung natürlicher Plaqueretentionsstellen)
- Vorreinigen der intraalveolären Knochtasche und Wurzelreinigung.
- Drehzahlempfehlung: 8.000 - 12.000 min⁻¹

fine grit

- gentle removal of supra- and subgingival calculus or rather concretions.
- removal of natural plaque retention points.
- pre-cleaning of intraalveolar intrabony pocket and root cleaning.
- recommended speed: 8.000 - 12.000 r.p.m.

grain fin

- élimination, en toute sécurité, du tartre sus-gingival et sousgingival et d'autres dépôts.
- odontoplastie (Élimination des zones de rétention de plaque dentaire naturelles)
- pre-nettoyage d'une poche intra-osseuse intra-alvéolaire et nettoyage des racines.
- vitesse recommandée: 8.000 - 12.000 min⁻¹

grano fino

- eliminación, de manera cuidadosa, del cálculo subgingival y supregingival, y de otras concreciones.
- eliminación de placas de retención naturales, es decir de grietas, fisuras y bifurcaciones mediante operaciones odontoplásticas.
- limpieza previa de la bolsa infraósea y limp. de los raices.
- velocidad recomendada: 8.000 - 12.000 min⁻¹

Extra feine Körnung

- Abschließende Wurzelglättung, auch bei beginnender Furkationsbeteiligung.
- Glättung des Wurzelzementes bei parodontal geschädigten Zähnen.
- Entfernung von Zementüberschüssen nach dem Einsetzen von festsitzendem Zahnersatz.

extra fine grit

- final root and smoothing, also at early infestation of furcation.
- smoothing of the root cementum of parodontal damaged teeth.
- removal of cementum surplus after fitting of crowns and bridges.

grain extra fin

- lissage final des racines, même en cas de bifurcation initiale.
- lissage du ciment des racines de dents cariées dans la zone parodontale.
- élimination des excédents de ciment après la mise en place des couronnes et bridges.

grano extra fino

- limpieza final y alisado de las raíces, incluso en caso de bifurcación inicial.
- alisado del cemento de las raíces de dientes deterioradas en el ámbito parodontal.
- eliminación del cemento excesivo después de colocar coronas y puentes.

- 8406LF
- 8406LEF

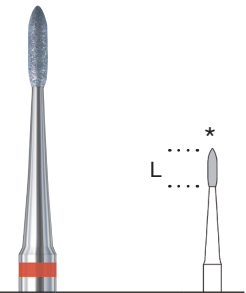

● W/RA/CA ISO 806 204 261 514...	8406LF/...	012
● W/RA/CA ISO 806 204 261 504...	8406LEF/...	012
L mm		5,0

- 8407LF
- 8407LEF

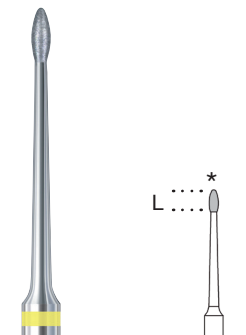

● W/RA/CA ISO 806 204 259 514...	8407LF/...	012
● W/RA/CA ISO 806 204 259 504...	8407LEF/...	012
L mm		2,9

- * Auch als Hartmetall-Instrumente Longlife Perio-Pro erhältlich.
- * Also available as carbide instruments Longlife Perio-Pro.
- * Egalement disponible en instruments carbure Longlife Perio-Pro.
- * También disponible como instrumentos de carburo Longlife Perio-Pro.

- feine Körnung, fine grit, grain fin, grano fino
- extra feine Körnung, extra fine grit, grain extra fin, grano extra fino



INFO

Sonderprospekt anfordern!
Please ask for our special leaflet!
Demandez notre prospectus spécial!
Pidan Vdes. nuestro folleto especial!

Polierer

Polishers • Polissoirs • Pulidores



Zahnmedizin

Dentistry • Odontologie • Odontologia

Universalvorpolyerier für alle Restaurationsmaterialien Universal pre-polishers, for all restoration materials Pré-polissoirs universels pour tous matériels de restauration Pulidores universales para todos los materiales de restauraciones	38
<hr/>	
2-stufiges diamantdurchsetztes Poliersystem für (auch hochgefüllte) Komposite 2-step diamond interspersed polishing system for composite (also high filled) Système de polissage en 2 étapes entremêlé des diamants pour composites (aussi les fortement chargés) Sistema de pulimento en 2 etapas entremezclado con diamantes para composites (también con proporciones elevadas)	39
<hr/>	
2-stufiges Poliersystem für Komposite 2-step polishing system for composite Système de polissage en 2 étapes pour composites Sistema de pulimento en 2 etapas para composites	40
<hr/>	
2-stufiges Poliersystem für Edelmetall-Legierungen, NEM und Amalgam 2-step polishing system for precious and non-precious metal alloys, amalgam Système de polissage en 2 étapes pour alliages de métaux précieux, non précieux et amalgame Sistema de pulimento en 2 etapas para aleaciones de metales preciosos y non-preciosos, amalgama	41
<hr/>	
2-stufiges diamantdurchsetztes Poliersystem für Keramik/Silikatkeramik 2-step diamond interspersed polishing system for ceramics/silicate ceramics Système de polissage en 2 étapes, mélangé des diamants pour la céramique/céramique silicatée Sistema de pulimento en 2 etapas entremezclado con diamantes para cerámica/cerámica de silicatos	42
<hr/>	
2-stufiges diamantdurchsetztes Poliersystem für Zirkonoxid 2-step diamond interspersed polishing system for zirconia Système de polissage en 2 étapes entremêlé des diamants pour l'oxyde de zirconie Sistema de pulimento en 2 etapas entremezclado con diamantes para dióxido de circonio	43
<hr/>	
Polierbürsten für Restaurationen Polishing brush for restorations Brosses à polissage pour les restaurations Cepillo para el pulido de restauraciones	44
<hr/>	
Soft Disc/4-stufiges Polierscheibensystem für Gold, Komposite und Amalgam Soft disc/4 step polishing disc system for gold, composite and amalgam Soft disque/système de disque de polissage en 4 étapes pour l'or, composite et amalgame Soft Disc/Sistema de discos de pulimento en 4 etapas para oro, composites y amalgama	45
<hr/>	
Polierer für die Prophylaxe Polishers for prophylaxis Polissoirs pour la prophylaxie Pulidores para profilaxia	46
<hr/>	
Bürsten für die Prophylaxe Brushes for prophylaxis Brosses pour la prophylaxie Cepillos para profilaxia	47
<hr/>	

Universalvorpolyierer für alle Restaurationsmaterialien
 Universal pre-polishers, for all restoration materials
 Pré-polissoirs universels pour tous matériels de restauration
 Pulidores universales para todos los materiales de restauraciones



Vorpolitur, weiß

Siliziumkarbid (SiC), Silicon
 Korngröße grob
 Bindungshärte weich

pre-polishing, white

silicon carbide (SiC), silicon
 grit size coarse
 bond hardness soft

prépolissage, blanc

carbure de silicium (SiC), silicone
 taille de grain gros
 dureté de liaison doux

prepulimento, blanco

carburo de silicio (SiC), silicon
 tamaño de grano grueso
 dureza de la ligazón blando



			
W/RA/CA ISO 658 204 ...	9607G/070 030 522 070	9608G/030 297 522 030	9609G/050 274 522 050
L mm	10,00	7,50	10,00



2-stufiges diamantdurchsetztes Poliersystem für (auch hochgefüllte) Komposite

2-step diamond interspersed polishing system for composite (also high filled)

Système de polissage en 2 étapes entremêlé des diamants pour composites (aussi les fortement chargés)

Sistema de pulimento en 2 etapas entremezclado con diamantes para composites (también con proporciones elevadas)

Politur, rosa beige

Diamant, PUR
Korngröße mittel
Bindungshärte mittel

polishing, pink beige

diamond, PUR
grit size medium
bond hardness medium

polissage, rose beige

diamant, PUR
taille de grain moyen
dureté de liaison moyen

pulimento, rosa beige

diamante, PUR
tamaño de grano medio
dureza de la ligazón media



FG ISO 803 314 ...					9588/030 294 523 030
W/RA/CA ISO 803 204 ...	9587/060 030 523 060	9588/030 297 523 030	9589/040 274 523 040	9591/140 543 523 140	
L mm	7,50	7,50	10,00	1,60	6,50

Endpolitur, hellgrau beige

Diamant, PUR
Korngröße fein
Bindungshärte mittel

end-polishing, grey beige

diamond, PUR
grit size fine
bond hardness medium

polissage final, gris clair beige

diamant, PUR
taille de grain fin
dureté de liaison moyen

pulimento final, gris claro beige

diamante, PUR
tamaño de grano fino
dureza de la ligazón media



FG ISO 803 314 ...					9578/030 294 513 030
W/RA/CA ISO 803 204 ...	9577/060 030 513 060	9578/030 297 513 030	9579/040 274 513 040	9581/140 543 513 140	
L mm	7,50	7,50	10,00	1,60	6,50



diamantdurchsetzt/diamond interspersed/entremêlé des diamants/entremezclado con diamantes

Politur, gelb

Edelkorund (Al₂O₃), Silikon
 Korngröße mittel
 Bindungshärte weich

Auch zur Entfernung von
 Klebstoffresten nach der
 Bracketentfernung geeignet.

polishing, yellow

high-grade corundum (Al₂O₃),
 silicon
 bond grit size medium
 bond hardness soft

Also suitable for the removal of
 adhesive residues after bracket
 treatment.

polissage, jaune

corindon affiné (Al₂O₃),
 liaison silicone
 taille de grain moyen
 dureté de liaison doux

Aussi approprié pour
 enlèvement des restes
 d'adhésif après le traitement
 de brackets.

pulimento, amarillo

corindon fino (Al₂O₃), silicona
 tamaño de grano mediano
 dureza de la ligazón blanda

También adecuado para la elimi-
 nación de retales de adhesivos
 después de quitar brackets.



W/RA/CA ISO 618 204 ...	9667/070 030 522 070	9668/030 297 522 030	9669/050 274 522 050
L mm	10,00	7,50	10,00

Endpolitur, blau

Edelkorund (Al₂O₃),
 Silikon
 Korngröße fein
 Bindungshärte weich

end-polishing, blue

high-grade corundum (Al₂O₃),
 silicone bond
 grit size fine
 bond hardness soft

polissage final, bleu

corindon affiné (Al₂O₃),
 liaison silicone
 taille de grain fin
 dureté de liaison doux

pulimento final, azul

corindon fino (Al₂O₃),
 ligazón silicona
 tamaño de grano fino
 dureza de la ligazón blanda



W/RA/CA ISO 618 204 ...	9677/070 030 512 065	9678/030 297 512 030	9679/050 274 512 050
L mm	10,00	7,50	10,00

2-stufiges Poliersystem für Edelmetall-Legierungen, NEM und Amalgam

2-step polishing system for precious and non-precious metal alloys, amalgam

Système de polissage en 2 étapes pour alliages de métaux précieux, non précieux et amalgame

Sistema de pulimento en 2 etapas para aleaciones de metales preciosos y non-preciosos, amalgama



Politur, braun

Siliziumkarbid (SiC), PUR
Korngröße mittel
Bindungshärte mittel

polishing, brown

silicon carbide (SiC), PUR
grit size medium
bond hardness medium

polissage, marron

carbure de silicium (SiC), PUR
taille de grain moyen
dureté de liaison moyen

pulimento, marrón

carburo de silicio (SiC), PUR
tamaño de grano medio
dureza de la ligazón media



FG ISO 853 314 ...				9608/030 294 523 030		
W/RA/CA ISO 653 204 ...	9607/065 030 523 065	9608/030 297 523 030	9609/050 274 523 050		9604/100 310 523 100	9611/140 543 523 140
L mm	9,50	7,50	10,00	6,50	2,40	1,60

Endpolitur, grün

Siliziumkarbid (SiC), PUR
Korngröße fein
Bindungshärte weich

end-polishing, green

silicon carbide (SiC), PUR
grit size fine
bond hardness soft

polissage final, vert

carbure de silicium (SiC), PUR
taille de grain fin
dureté de liaison doux

pulimento final, verde

carburo de silicio (SiC), PUR
tamaño de grano fino
dureza de la ligazón blando



FG ISO 853 314 ...				9618/030 294 512 030		
W/RA/CA ISO 653 204 ...	9617/065 030 512 065	9618/030 297 512 030	9619/050 274 512 050		9621/140 543 512 140	
L mm	9,50	7,50	10,00	6,50	1,60	



2-stufiges diamantdurchsetztes Poliersystem für Keramik/Silikatkeramik

2-step diamond interspersed polishing system for ceramics/silicate ceramics

Système de polissage en 2 étapes, mélangé des diamants pour la céramique/céramique silicatée

Sistema de pulimento en 2 etapas entremezclado con diamantes para cerámica/cerámica de silicatos

Politur, rot gelb

Diamant, PUR
Korngröße mittel
Bindungshärte weich

polishing, red yellow

diamant, PUR
grit size medium
bond hardness soft

polissage, rouge jaune

diamant, PUR
taille de grain moyen
dureté de liaison doux

pulimento, rojo amarillo

diamante, PUR
tamaño de grano mediano
dureza de la ligazón blando

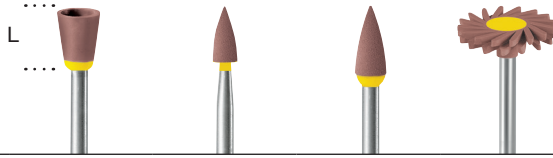

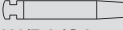
 W/RA/CA ISO 803 204 ...	9807/060 030 522 060	9808/030 297 522 030	9809/040 257 522 040	9811/140 543 522 140
L mm	7,50	7,50	10,00	1,60

Endpolitur, grün gelb

Diamant, PUR
Korngröße fein
Bindungshärte weich

end-polishing, green yellow

diamant, PUR
grit size fine
bond hardness soft

polissage final, vert jaune

diamant, PUR
taille de grain fin
dureté de liaison doux

pulimento final, verde amarillo

diamante, PUR
tamaño de grano fino
dureza de la ligazón blando

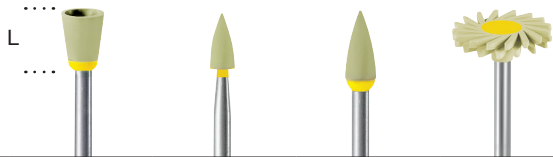

 W/RA/CA ISO 803 204 ...	9817/060 030 512 060	9818/030 297 512 030	9819/040 257 512 040	9821/140 543 512 140
L mm	7,50	7,50	10,00	1,60



diamantdurchsetzt/diamond interspersed/entremêlé des diamants/entremezclado con diamantes



2-stufiges diamantdurchsetztes Poliersystem für Zirkonoxid

2-step diamond interspersed polishing system for zirconia

Système de polissage en 2 étapes entremêlé des diamants pour l'oxyde de zircone

Sistema de pulimento en 2 etapas entremezclado con diamantes para dióxido de circonio



Pursh®

Politur, türkis gelb

Diamant, PUR
Korngröße mittel
Bindungshärte mittel

polishing, turquoise yellow

diamant, PUR
grit size medium
bond hardness medium

polissage, turquoise jaune

diamant, PUR
taille de grain moyen
dureté de liaison moyen

pulimento, turquesa amarillo

diamante, PUR
tamaño de grano mediano
dureza de la ligazón mediana

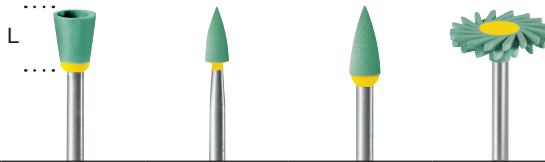

	W/RA/CA ISO 803 204 ...	9907/060 030 523 060	9908/030 297 523 030	9909/040 257 523 040	9911/140 543 523 140
L mm		7,50	7,50	10,00	1,60

Endpolitur, rosa gelb

Diamant, PUR
Korngröße fein
Bindungshärte mittel

**end-polishing,
pink yellow**

diamant, PUR
grit size fine
bond hardness medium

**polissage final,
rose jaune**

diamant, PUR
taille de grain fin
dureté de liaison moyen

**pulimento final,
rosa amarillo**

diamante, PUR
tamaño de grano fino
dureza de la ligazón mediana

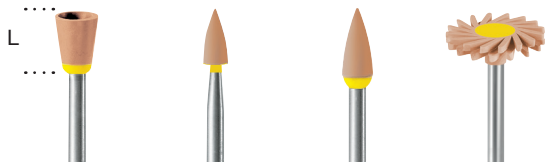

	W/RA/CA ISO 803 204 ...	9917/060 030 513 060	9918/030 297 513 030	9919/040 257 513 040	9921/140 543 513 140
L mm		7,50	7,50	10,00	1,60



diamantdurchsetzt/diamond interspersed/entremêlé des diamants/entremezclado con diamantes

SIC Brush

Spezialbürste für die Politur von Restaurationen aus Keramik, Komposite und Metall
 special brush for polishing restorations made from ceramic, composite and metals
 brosses spéciales pour le polissage des restaurations du céramique des composites et métaux
 cepillo especial para el pulido de restauraciones de cerámica, e composites y de metales

für die Anwendung
 ohne Polierpaste,
 beige

Siliziumkarbid (SiC), Polyamid
 Korngröße mittel

for the application without
 polishing paste,
 beige

silicon carbide (SiC), polyamide
 grit size medium

pour l'application
 sans pâte à polir,
 beige

carbure de silicium (SiC),
 polyamide
 taille de grain moyen

para aplicación
 sin pasta de pulir,
 beige

carburo de silicio (SiC), polyamid
 tamaño de grano mediano

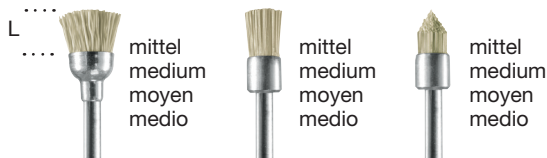

 W/RA/CA ISO 653 204 ...	9735SiC/060 541 523 060	9730SiC/040 542 523 040	9731SiC/040 129 523 040
L mm	5,50	6,50	6,50

Soft Disc/4-stufiges Polierscheibensystem für Gold, Komposite und Amalgam
 Soft disc/4step polishing disc system for gold, composite and amalgam
 Soft disque/système de disque de polissage en 4 étapes pour l'or, composite et amalgame
 Soft disc/sistema de discos de pulimento en 4 etapas para oro, composites y amalgama



Soft Disc

Arbeitsgang: siehe Tabelle
 Edelkorund (Al₂O₃), Polyester
 Korngröße: siehe Tabelle
 flexibel

Soft Disc

step: see table
 high-grade corundum (Al₂O₃),
 polyester
 grit size: see table
 flexible

Soft Disc

phase de travail: voir tableau
 corindon affiné (Al₂O₃),
 polyester
 taille de grain: voir tableau
 flexible

Soft Disc

fase de trabajo: vea tabla
 corindon fino (Al₂O₃), poliéster
 grano: vea tabla
 flexible

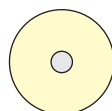
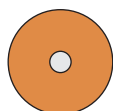

Soft Disc Träger
 Soft Disc mandrel
 Soft Disc mandrin
 mandril Soft Disc



Größe 100 diameter 100 taille 100 tamaño 100 ISO 620 900		9590G/100	9590M/100	9590F/100	9590EF/100
Größe 140 diameter 140 taille 140 tamaño 140 ISO 620 900		9590G/140	9590M/140	9590F/140	9590EF/140
Farbe colour couleur color		rost red rouille óxido	orange orange orange naranja	hellorange light orange orange clair naranja claro	gelb yellow jaune amarillo
Korngröße grit size taille de grain grano		grob coarse gros grueso	mittel medium moyen mediano	fein fine fin fino	extra fein extra fine extra fin extra fino
Arbeitsgang step		Glätten smoothing	Vorpolitur pre-polishing	Glanzpolitur high lustre polishing polissage brillant	Hochglanz super high lustre polishing polissage brillant supérieure
phase de travail		lissage	prépolissage	polissage brillant	polissage brillant
fase de trabajo		alisado	prepulimento	pulimento de brillo	pulimento de brillo intenso



	W/RA/CA ISO 330 204 ...	312RS Wst 608 000 000
--	----------------------------	--------------------------

Soft Disc Set



Inhalt: **9590/100 Set** = 25 Scheiben je Körnung, Größe 100
9590/140 Set = 25 Scheiben je Körnung, Größe 140
 inklusive 1 Träger 312RS

content: **9590/100 Set** = 25 disc per grit size, diameter 100
9590/140 Set = 25 disc per grit size, diameter 140
 inclusive 1 mandrel 312RS

contenu: **9590/100 Set** = 25 disques par grain, taille 100
9590/140 Set = 25 disques par grain, taille 140
 inclus 1 mandrin 312RS

contenido: **9590/100 Set** = 25 discos por grano, tamaño 100
9590/140 Set = 25 discos por grano, tamaño 140
 incl. 1 mandril 312RS

für die Anwendung
 mit Polierpaste,
 weiß

Silikonpolierer
 (ohne Schleifkorn)
 Bindungshärte mittel

for the application with
 polishing paste,
 white

silicone polisher
 (without abrasive grain)
 bond hardness medium

pour l'application avec
 pâte à polir,
 blanc

polissoir en silicone
 (sans grain abrasif)
 dureté de liaison moyen

para aplicación con pasta
 de pulir,
 blanco

pulidores de silicona
 (sin grano abrasivo)
 dureza de la ligazón media

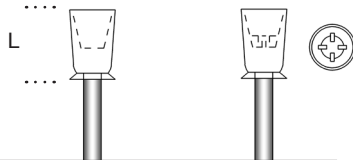

	W/RA/CA ISO 008 204 ...	9630/060 030 003 060	9631/060 034 003 060
L mm		10,00	10,00

Einmalinstrument
 single use instrument
 usage unique
 usar una vez

für die Anwendung
 ohne Polierpaste,
 weiß, grün, gelb

BIMS PUR,
 Korngröße extra fein

for the application
 without polishing paste,
 white, green, yellow

pumice PUR,
 grit size fine

pour l'application sans
 pâte à polir,
 blanc, vert, jaune

BIMS PUR,
 taille de grain extra fin

para aplicación
 sin pasta de pulir,
 blanco, verde, amarillo

BIMS PUR,
 tamaño de grano fino



	W/RA/CA ISO 003 244 ...	9633M/070 034 503 070	9633S/070 034 502 070	9633SS/070 034 501 070
L mm		10,00	10,00	10,00

Einmalinstrument/Kunststoffschaft
 single use instrument/plastic shank
 usage unique/tige en matière plastique
 uzar una vez/material del mango de plástico

für die Entfernung
 von Kunststoffresten
 nach der Bracketent-
 fernung geeignet

Spezialpolierer, verletzt
 nicht die natürliche
 Zahnschubstanz

for removal of
 adhesive residues
 after debonding

special polishers do
 not harm the enamel

l'enlèvement des restes
 d'adhésif après le
 traitement de brackets

polisseuse spéciale, blessée
 pas le naturel substance dentaire

para la eliminación
 de retales de adhesivos
 después de quitar brackets

pulidora especial, lesionada
 no el natural sustancia dental



	W/RA/CA ISO 633 244 ...	9650/030 030 544 060	9650/050 243 544 050
L mm		7,50	10,00

für die Anwendung
mit Polierpaste

Polyamidbürsten
(ohne Schleifkorn)

for the application with
polishing paste

polyamide brushes
(without abrasive grit)

pour l'application avec
pâte à polir

brosse polyamide
(sans grain abrasif)

para aplicación con
pasta de pulir

cepillos de poliamid
(sin grano abrasivo)

hart/hard/dur/duro

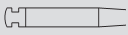

 W/RA/CA ISO 110 204 ...	9635H/060 010 700 060	9730H/040 010 700 040	9731H/040 131 700 040
L mm	5,50	6,00	6,50

Einmalinstrumente
single use instruments
usage unique
usar una vez

weich/soft/doux/blando



 W/RA/CA ISO 110 204 ...	9635/060 541 003 065	9730/040 542 003 040	9731/040 129 003 040
L mm	5,50	6,00	6,50

Einmalinstrumente
single use instruments
usage unique
usar una vez

super weich/super soft/super doux/super blando

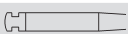

 W/RA/CA ISO 110 204 ...	9635S/060 010 300 060	9730S/040 010 300 040	9731S/040 131 300 040
L mm	5,50	6,00	6,50

Einmalinstrumente
single use instruments
usage unique
usar una vez

Schleifkörper

Abrasives • Abrasifs • Abrasivos



Zahnmedizin

Dentistry • Odontologie • Odontologia

Schleifkörper für Keramik, Kunststoffe, Metall-Legierungen,
Schmelz
Abrasives for ceramic, acrylics, metal alloys, enamel
Abrasis pour céramique, acrylique, alliages métalliques, émail
Abrasivos para cerámica, acrílico, aleaciones, metálicas,
esmalte 50

Schleifkörper für Komposite
Abrasives for composites
Abrasis pour composites
Abrasivos para composite 51

für Keramik, Kunststoffe,
Metall-Legierungen,
Schmelz , grün

Siliziumkarbid
Schleifkörper (SiC), grün
Keramische Bindung
Korngröße mittel
Bindungshärte mittel

for ceramic, acrylics,
metal alloys, enamel,
green

silicon carbide
abrasives (SiC), green
ceramic bond
grit size medium
bonding hardness medium

pour céramique, acrylique,
alliages métalliques, émail,
vert

abrasifs en carbure de silicium
(SiC), vert
liaison céramique
taille de grain moyen
dureté de liaison moyen

para cerámica,acrílico,
aleaciones metálicas,
esmalte, verdes

abrasivos de carburo
de silicio (SiC), verde
ligazón cerámica
tamaño de grano medio
dureza de la ligazón media

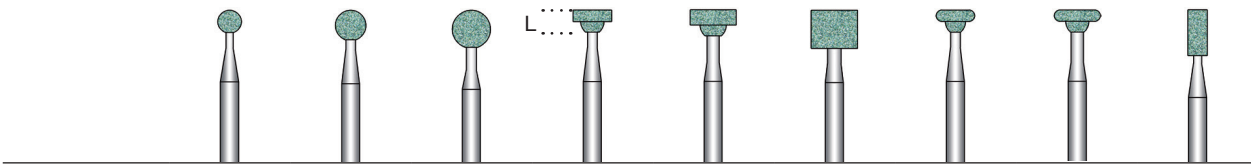

W/RA/CA ISO 655 204 ...	601/030 001 523 030	602/040 001 523 040	603/050 001 523 050	619/050 042 523 050	622/060 042 523 060	624/060 109 523 060	626/050 068 523 050	627/060 068 523 060	637/025 110 523 025
L mm	-	-	-	2,90	3,40	5,00	2,90	2,90	6,00

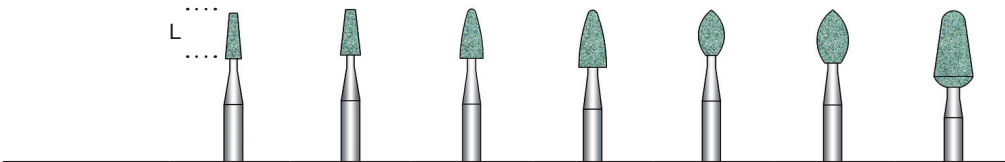

W/RA/CA ISO 655 204 ...	648/020 171 523 020	649/025 171 523 025	661/030 243 523 030	662/035 243 523 035	666/033 257 523 033	667/040 257 523 040	671/050 260 523 050
L mm	6,00	6,00	6,50	7,50	6,00	7,00	10,00

für Feinstbearbeitung
 von Komposite, weiß

Edelkorund Arkansas
 Schleifkörper (Al₂O₃),
 weiß
 Keramische Bindung
 Korngröße extra fein
 Bindungshärte hart

for smooth grinding
 of composites, white

high-grade corundum
 arkansas abrasives (Al₂O₃),
 white
 ceramic bond
 grit size extra fine
 bonding hardness hard





pour le finissage
 de composites, blanc

abrasifs arkansas
 en corindon affiné (Al₂O₃),
 blanc
 liaison céramique
 taille de grain extra fin
 dureté de liaison dure

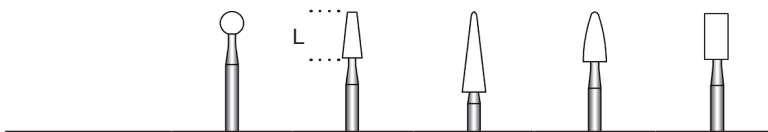
para correcciones finas
 de composite, blancos

abrasivos arkansas
 de corindón fino (Al₂O₃),
 blanco
 ligazón cerámica
 tamaño de grano extra fino
 dureza de la ligazón dura



						
	FG ISO 635 314 ...	601/030 001 504 030	649/025 171 504 030	653/030 204 504 030	661/030 243 504 030	638/030 110 504 030
	W/RA/CA ISO 635 204 ...	601/030 001 504 030	649/025 171 504 030	653/030 204 504 030	661/030 243 504 030	
L mm	-	6,00	10,50	6,50	6,0	



Diamant

Diamond • Diamant • Diamante











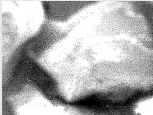

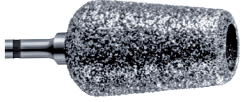



Zahntechnik



Dental Technique • Prothese Dentaire • Protesis Dental

Anwendungsbeispiele Examples of application Exemples d'application Ejemplos de aplicaciones	54+55
<hr/>	
Dia <i>TWISTER</i>	56
<hr/>	
Premium Diamantschleifer Premium diamond instruments Instruments diamantés supérieurs Instrumentos diamantados superiores	57-63
<hr/>	
ZIRAMANT	64+65
<hr/>	
Diamantscheiben, montiert Diamond discs, mounted Disques diamantés, montés Discos diamantados, montados	66+67
<hr/>	
Longlife Sinter-Diamantschleifer Longlife sintered diamond instruments Diamant dans la masse Longlife Instrumentos diamantados sinterizados Longlife	68+69
<hr/>	

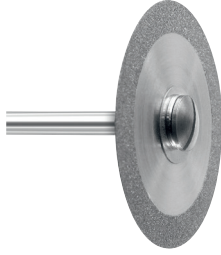

Einsatzgebiet application area domaine d'application uso en sector	Arbeitsgang working process phase de travail fase de trabajo	Körnung R.E.M. (30x) grit D.S.M. D.S.M. (30x) grain M.E.B. M.E.B. (30x) grano M.E.R. (30x)	Instrumentenbeispiel examples of instr. exempl. d'instruments ej. de los instrumentos	ISO-Ø	empf. Drehzahl min ⁻¹ recommended speed vit. de rotation rec. veloc. recomendada
KFO-Prothesen- kunststoff KFO for denture acrylic résine pour prothèse amovible acrilica para ortodoncia y dentadura	zügiges Vorschleifen faster pregrinding dégrossissage rapide rectificado inicial rápido		DT4880/100 	070 – 120	22.000 – 15.000
Kunststoff, Gips acrylic, plaster résine, plâtre acrilica, yeso	Vorschleifen pregrinding dégrossissage rectificado inicial		5405/115 	050 – 075 085 – 115	32.000 – 15.000 18.000 – 15.000
Keramik, Komposit ceramic, composite céramique, composite cerámica, composite	Vorschleifen pregrinding dégrossissage tallado inicial		6863/019 	018 – 063	35.000 – 15.000
	Formschleifen shape grinding façonnage rectificado de forma		859/018 	009 – 085	
	Feinschleifen fine grinding abrasion de précision rectificado fino		8850/023 	012 – 060	
Keramik ceramic céramique cerámica	Oberflächen- Feinstbearbeitung finest surface treatments superfinition de surfaces preparaciones muy finas de superficies		390EF/018 	012 – 047	35.000 – 15.000
Zirkonoxid Zirconia oxyde de zirconium óxido de zirconio	Beschleifen/Feinschleifen grinding/fine grinding meulage/abrasion de précision afilarse/rectificado fino		6860Z/014  8860Z 	009 – 025	200.000 – 180.000*

* Turbine mit Kühlung/turbine with cooling/turbine avec refroidissement/turbina con refrigeración

Einsatzgebiet	Arbeitsgang	Körnung R.E.M.(30x)	Instrumentenbeispiel	ISO-Ø	empf. Drehzahl min ⁻¹
application area	working process	grit D.S.M. (30x)	examples of instr.		recommended speed
domaine d'application	phase de travail	grain M.E.B. (30x)	exempl. d'instruments		vit. de rotation rec.
uso en sector	fase de trabajo	grano M.E.R. (30x)	ej. de los instrumentos		veloc. recomendada
Gips, Komposit, Keramik plaster, composite, ceramic plâtre, composite, céramique yeso, composite, ceramica	Modellherstellung, Separieren von Brückengliedern model fabrication separating of bridge links fabrication de modèles séparation des éléments de bridge fabricación de modelos separación de elementos de puente	Diamant-Scheiben, montiert mittel & fein diamond discs mounted medium + fine disques diamantés, monté moyen + fin discos diamantados, montados medio + fino	911H/220 	080 – 300	35.000 – 9.000
CrCo-Legierungen CrCo-alloys	Formschleifen shape grinding façonnage rectificado de forma	Longlife Sinter-Diamant, grob Longlife Sintered diamond instruments, coarse diamant dans la masse Longlife, gros instrumentos diamant- tados sinterizados Longlife, grueso	1893/050 	031 – 210	28.000 – 8.000
alliages CrCo aleaciones cromocobaltos	feinschleifen fine grinding abrasion de précision rectificado fino	Longlife Sinter-Diamant, mittel Longlife Sintered diamond instruments, medium diamant dans la masse Longlife, moyen instrumentos diamant- tados sinterizados Longlife, medio	3368/016 	016 – 080	32.000 – 10.000



DiaTWISTER

Europa-Patent Nr. 1157627
 Europe patent no. 1157627
 Brevet d'Europe no. 1157627
 Patente europea no. 1157627

- für das kühle Vorschleifen von Kfo- und Prothesenkunststoff
- für das Bearbeiten von individuellen Abdrucklöffeln und Gips
- for cool pregrinding of orthodontic and denture acrylics
- for the processing of individual impression trays and plaster
- pour le dégrossissage des résines orthodontiques et prothétiques sans échauffement
- pour le traitement de PEI et plâtre synthétique
- para el rectificado frio inicial de resina para ortodoncia y protética
- para la elaboración de cubetas de impresión individuales y yeso

Mega grobe Körnung/mega coarse grit/grain mega gros/grano hiper grueso

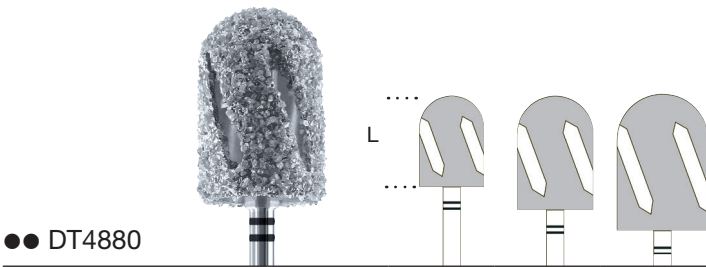

●● DT4880



●● H/HP/PM DiaTWISTER	DT4880/...	085	100	120
L mm		12,5	15,0	18,0



●● DT4854R



●● H/HP/PM DiaTWISTER	DT4854R/...	100	120
L mm		16,0	19,0

Super grobe Körnung/super coarse grit/grain super gros/grano super grueso



● DT5880



● H/HP/PM DiaTWISTER	DT5880/...	080	095	115
L mm		12,0	15,0	18,0





● DT5854R

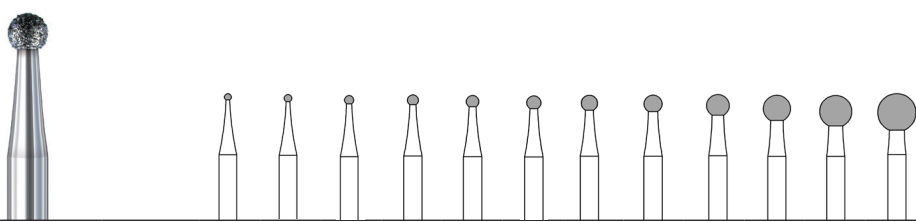

● H/HP/PM DiaTWISTER	DT5854R/...	095	115
L mm		15,5	18,5

801





H/HP/PM ISO 806 104 001 524...	801/...	009	010	012	014	016	018	021	023	029	035	042	050
-----------------------------------	---------	-----	-----	-----	-----	-----	-----	-----	-----	-----	-----	-----	-----

805

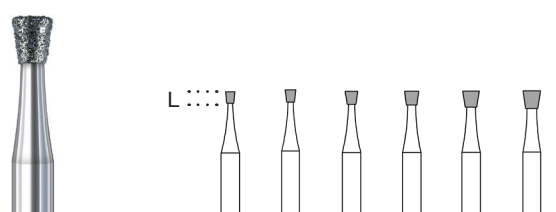



H/HP/PM ISO 806 104 010 524...	805/...	012	014	016	018	021	023
L mm		1,5	1,6	1,7	1,8	2,1	2,3

807

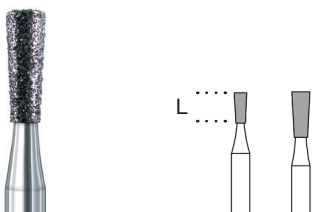



H/HP/PM ISO 806 104 225 524...	807/...	016	023
L mm		4,0	6,0

835

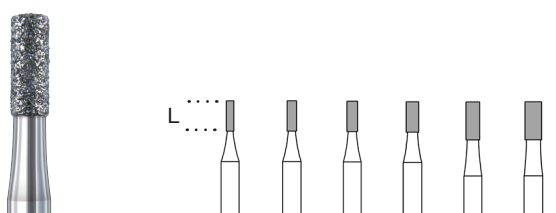



H/HP/PM ISO 806 104 107 524...	835/...	010	012	014	016	018	021
L mm		4,0	4,0	4,0	4,0	5,0	5,0

836

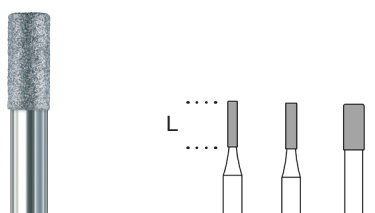



H/HP/PM ISO 806 104 110 524...	836/...	012	014	027
L mm		6,0	6,0	6,0

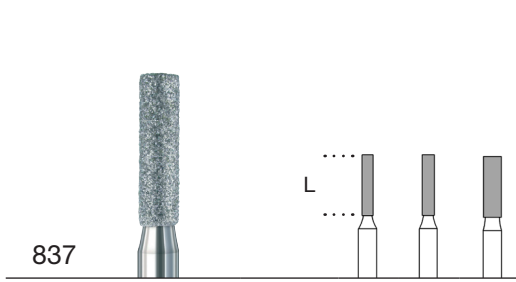

				
H/HP/PM	837/...	014	016	023
ISO 806 104 111 524...				
L mm		8,0	8,0	8,0



			
H/HP/PM	842/...		021
ISO 806 104 113 524...			
L mm			12,0

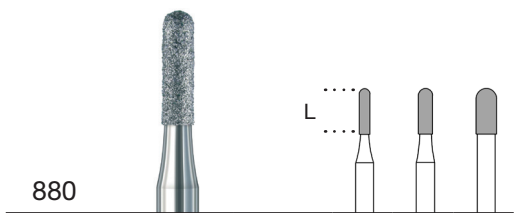

				
H/HP/PM	880/...	014	018	027
ISO 806 104 140 524...				
L mm		6,0	6,0	6,0



			
H/HP/PM	842R/...		021
ISO 806 104 143 524...			
L mm			12,0





				
H/HP/PM	845/...	010	012	016
ISO 806 104 168 524...				
L mm		4,0	4,0	4,0

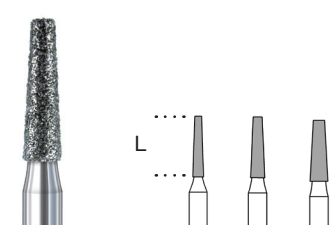

			
H/HP/PM	846/...		025
ISO 806 104 171 524...			
L mm			7,0

847





H/HP/PM ISO 806 104 172 524...	847/...	014	018	023
L mm		8,0	8,0	8,0

848

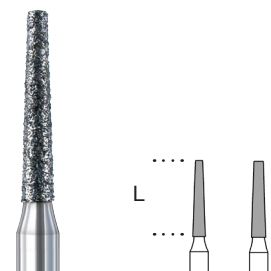



H/HP/PM ISO 806 104 173 524...	848/...	016	018
L mm		10,0	10,0

● 6854
 854
 ● 8854

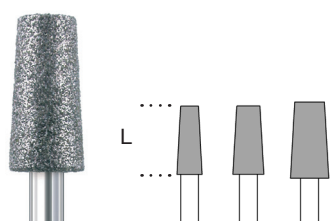



● H/HP/PM ISO 806 104 172 534...	6854/...			050
H/HP/PM ISO 806 104 172 524...	854/...	033	040	
● H/HP/PM ISO 806 104 172 514...	8854/...	033	040	
L mm		9,0	9,0	10,0

● 6854R
 854R
 ● 8854R

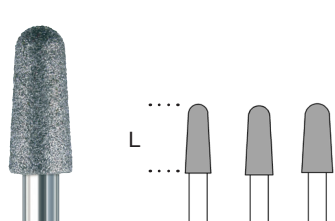



● H/HP/PM ISO 806 104 198 534...	6854R/...		035	
H/HP/PM ISO 806 104 198 524...	854R/...	033		040
● H/HP/PM ISO 806 104 198 514...	8854R/...	033		040
L mm		9,0	9,1	9,0



849



H/HP/PM	849/...	016
ISO 806 104 194 524...		
L mm		4,0



855



H/HP/PM	855/...	025
ISO 806 104 197 524...		
L mm		7,0



856



H/HP/PM	856/...	014
ISO 806 104 198 524...		
L mm		8,0

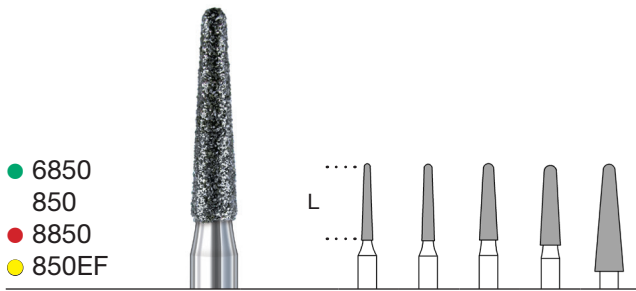

- 6850
- 850
- 8850
- 850EF



H/HP/PM	6850/...				025	
ISO 806 104 199 534...						
H/HP/PM	850/...	014	016	023		
ISO 806 104 199 524...						
H/HP/PM	850/...				037	
ISO 806 104 201 524...						
H/HP/PM	8850/...	014	016	023		
ISO 806 104 199 514...						
H/HP/PM	850EF/...		016			
ISO 806 104 199 504...						
L mm		10,0	10,0	10,0	10,4	14,0

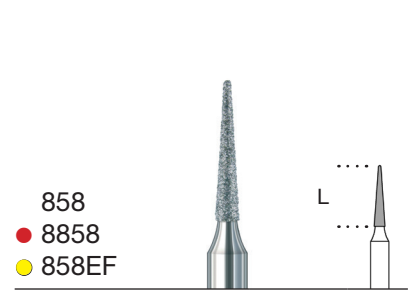

- 858
- 8858
- 858EF



H/HP/PM	858/...	014
ISO 806 104 165 524...		
H/HP/PM	8858/...	014
ISO 806 104 165 514...		
H/HP/PM	858EF/...	014
ISO 806 104 165 504...		
L mm		8,0

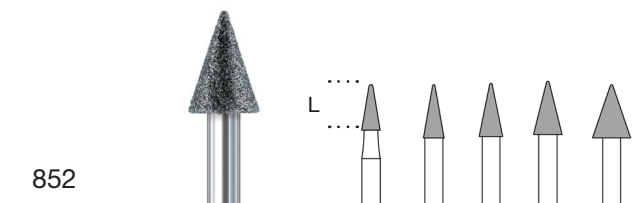

852



H/HP/PM	852/...	023	027	031	037	050
ISO 806 104 159 524...						
L mm		6,0	7,0	7,0	7,0	7,0

ISO-Ø 014-031 = ISO-Ø 037-050 =

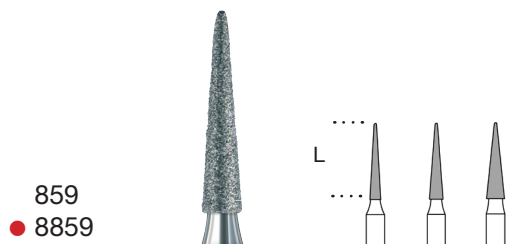

859
 ● 8859



H/HP/PM ISO 806 104 166 524...	859/...	014	018	023
● H/HP/PM ISO 806 104 166 514...	8859/...		018	
L mm		10,0	10,0	10,0



860
 ● 8860



H/HP/PM ISO 806 104 245 524...	860/...	012	016
● H/HP/PM ISO 806 104 245 514...	8860/...	012	
L mm		5,0	5,0



● 6862
 862



● H/HP/PM ISO 806 104 249 534...	6862/...		018	
H/HP/PM ISO 806 104 249 524...	862/...	014	018	023
L mm		8,0	8,0	8,0

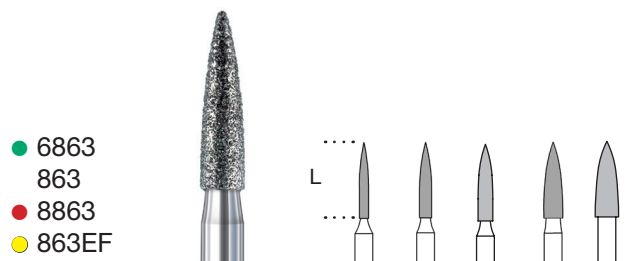

● 6863
 863
 ● 8863
 ● 863EF



● H/HP/PM ISO 806 104 250 534...	6863/...			019		
H/HP/PM ISO 806 104 250 524...	863/...	012	016		025	031
● H/HP/PM ISO 806 104 250 514...	8863/...	012	016			
● H/HP/PM ISO 806 104 250 504...	863EF/...	012				
L mm		10,0	10,0	10,1	10,0	10,0



390
 ● 8390
 ● 390EF



H/HP/PM ISO 806 104 274 524...	390/...	018
● H/HP/PM ISO 806 104 274 514...	8390/...	018
● H/HP/PM ISO 806 104 274 504...	390EF/...	018
L mm		3,7



368
 ● 8368
 ● 368EF



H/HP/PM ISO 806 104 257 524...	368/...	023
● H/HP/PM ISO 806 104 257 514...	8368/...	023
● H/HP/PM ISO 806 104 257 504...	368EF/...	023
L mm		5,0



379



H/HP/PM ISO 806 104 277 524...	379/...	014	023
L mm		2,8	4,2

909

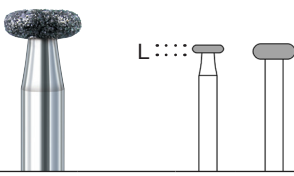

L: ...



H/HP/PM	909/...	040	055
ISO 806 104 068 524...			
L mm		1,0	2,0

818

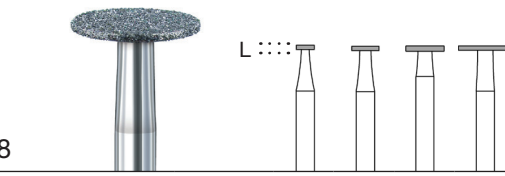

L: ...



H/HP/PM	818/...	023	035	050	070
ISO 806 104 041 524...					
L mm		0,6	0,6	0,6	0,6

812



L: ...



H/HP/PM	812/...	055
ISO 806 104 022 524...		
L mm		2,8

825

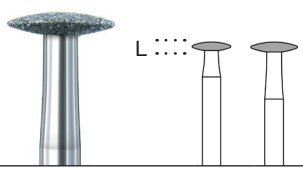

L: ...



H/HP/PM	825/...	050	060
ISO 806 104 304 524...			
L mm		1,1	1,3

830

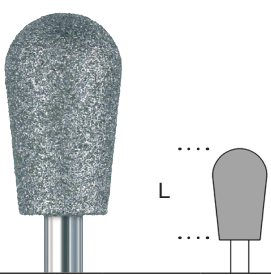

L: ...



H/HP/PM	830/...	070
ISO 806 104 237 524...		
L mm		12,0

● 5369
369

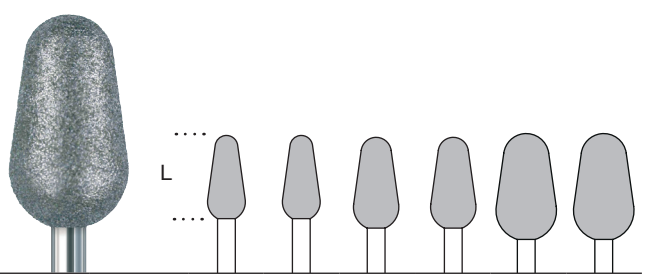

L: ...



● H/HP/PM	5369/...		055		065		085
ISO 806 104 263 544...							
H/HP/PM	369/...	050		060		080	
ISO 806 104 263 524...							
L mm		11,0	11,5	12,0	12,5	14,0	14,3

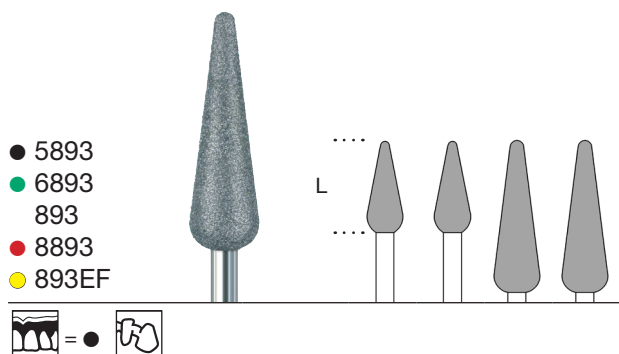

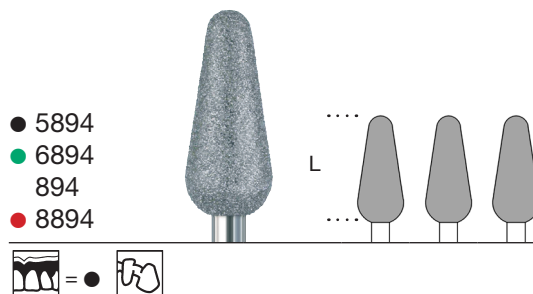

● 5893				
● 6893				
● 893				
● 8893				
● 893EF				
				
● H/HP/PM	5893/...		050	065
ISO 806 104 266 544...				
● H/HP/PM	6893/...		050	
ISO 806 104 266 534...				
H/HP/PM	893/...	047		060
ISO 806 104 266 524...				
● H/HP/PM	8893/...	047		
ISO 806 104 266 514...				
● H/HP/PM	893EF/...	047		
ISO 806 104 266 504...				
L mm		12,0	12,3	20,0

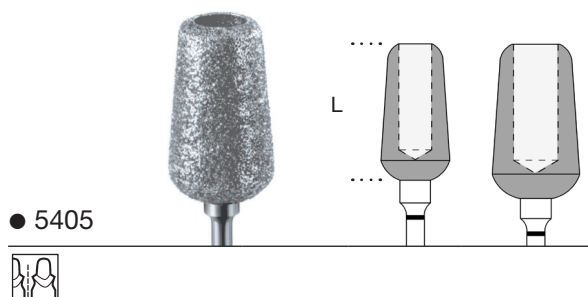

● 5894				
● 6894				
● 894				
● 8894				
				
● H/HP/PM	5894/...			065
ISO 806 104 263 544...				
● H/HP/PM	6894/...		063	
ISO 806 104 263 534...				
H/HP/PM	894/...	060		
ISO 806 104 263 524...				
● H/HP/PM	8894/...	060		
ISO 806 104 263 514...				
L mm		14,0	14,3	14,3

Hohlschleifer
 hollow instruments
 instruments creux
 instrumentos huecos



● 5405			
			
● H/HP/PM	5405/...	090	115
L mm		18,0	20,3

ZIRAMANT

Spezialdiamantierung für Zirkonoxid
 Special diamond coating for zirconia
 Diamantée spéciale pour oxyde de zirconium
 Recubrimiento diamantado especial para ZrO

- für das Bearbeiten von Zirkonoxid mit der Labor-Turbine und Wasserkühlung
- for working on zirconia with laboratory turbines and coolant
- pour le traitement de l'oxyde de zirconium avec turbine laboratoire et refroidissement à l'eau
- para el tratamiento de óxido de circonio con la turbina y refrigeración del spray

Punktförmiges und flächiges Ausschleifen
 grinding individual points and larger areas
 abrasion ponctuelle et de surfaces
 pulido en punta y liso

●● 6801LZ

	6801LZ/...	014
●● FG x-lg ISO 806 316 001 535...		

●● 6838LZ

	6838LZ/...	012
●● FG x-lg ISO 806 316 137 525...		
L mm		2,5

Formschleifen an flächigen, konkaven und schwer zugänglichen Bereichen
 shape grinding on larger, concaved and inaccessible areas
 façonnage de zones planes, concaves et à accès difficile
 rectificado en superficies lisas, concavas y de difícil acceso

●● 6855Z

	6855Z/...	025
●● FG lg ISO 806 315 197 535...		
L mm		6,0

●● 6860Z

	6860Z/...	014
●● FG lg ISO 806 315 245 535...		
L mm		5,0

●● 6379Z

	6379Z/...	023
●● FG lg ISO 806 315 277 535...		
L mm		4,2

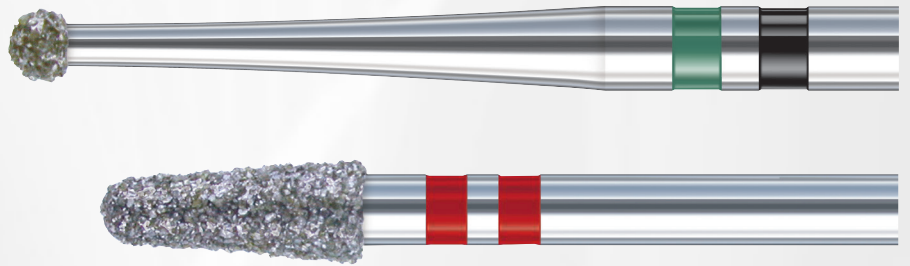

Feinbearbeitung mit geringer Rautiefe an kritischen Stellen und bruchgefährdeten Randbereichen
 smooth fine finishing with little roughness on critical areas and fragile edge areas
 finition à faible profondeur de rugosité à des endroits critiques et dans des zones de bordure fragiles
 trabajos precisos de menor profundidad de rugosidad en zonas críticas y zonas aledañas con riesgo de ruptura

●● 8838LZ

●● FG x-ig ISO 806 316 137 515...	8838LZ/...	009
L1 mm		2,3
L2 mm		11,8

●● 8855Z

●● FG ig ISO 806 315 197 515...	8855Z/...	021
L mm		6,0

●● 8860Z

●● FG ig ISO 806 315 245 515...	8860Z/...	010
L mm		5,0

●● 8379Z

●● FG ig ISO 806 315 277 515...	8379Z/...	019
L mm		4,2

INFO Sonderprospekt anfordern!
 Please ask for our special leaflet!
 Demandez notre prospectus spécial!
 Pidán Vdes. nuestro folleto especial!

Rand diamantdurchsetzt
 rim diamond interspersed
 bord diamanté
 perifería diamantada todo espesor

Kera-Flex

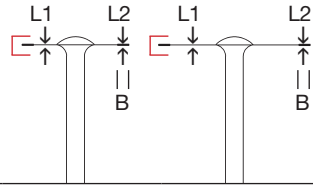

7911



H/HP/PM ISO 806 104 354 514...	7911/...	140	200
L1		0,15	0,15
L2		0,17	0,17
B		1,5	2,0

Kera-Super-Flex

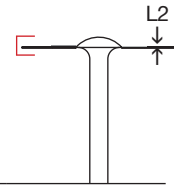

7912



H/HP/PM ISO 806 104 358 514...	7912/...	200
L2		0,17

Rand galvanisch belegt
 rim galvanic coated
 bord recouvert par galvanisation
 perifería recubrimiento galvánico

Super-Flex

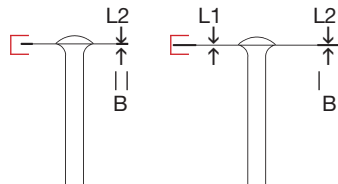

911H



H/HP/PM ISO 806 104 355 514...	911H/...	140	220
L1		0,06	0,06
L2		0,20	0,20
B		2,0	3,0

Super-Flex

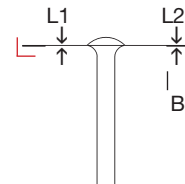

911HH



H/HP/PM ISO 806 104 356 514...	911HH/...	220
L1		0,06
L2		0,10
B		3,0

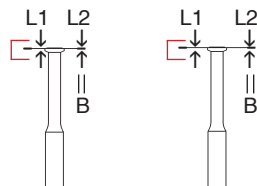

Super-Flex



943



H/HP/PM ISO 806 104 361 514...	943/...	080	100
L1		0,06	0,06
L2		0,15	0,15
B		1,0	1,0

-  = oben und unten diamantiert/top and bottom diamond-coated/
dessus et dessous diamantés/parte superior e inferior recubiertas de diamante
-  = unten diamantiert/ bottom diamond-coated/
dessous diamantés/ parte inferior recubiertas de diamante
-  = oben diamantiert/top diamond-coated/
dessus diamantés/ parte superior recubiertas de diamante



H/HP/PM	911/...	220
ISO 806 104 340 514...		
L1		0,10
L2		0,25
B		2,0



H/HP/PM	918PB/...	220
ISO 806 104 350 524...		
L1		0,10
L2		0,30
B		7,5



H/HP/PM	919P/...	220
ISO 806 104 351 524...		
L1		0,10
L2		0,20
B		7,5

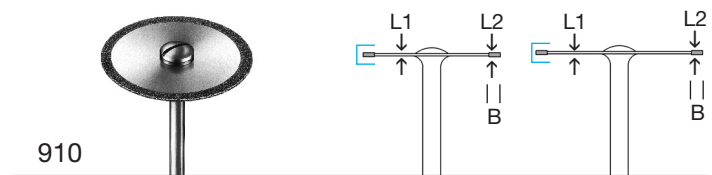

H/HP/PM	910/...	180	220
ISO 806 104 321 524...			
L1		0,25	0,25
L2		0,55	0,55
B		2,0	2,0



H/HP/PM	916/...	220
ISO 806 104 329 524...		
L1		0,30
L2		0,45
B		7,5



H/HP/PM	902/...	150
ISO 806 104 076 524...		
L2		3,3

Modellherstellung/model fabrication/fabrication de modèles/fabricación de modelos

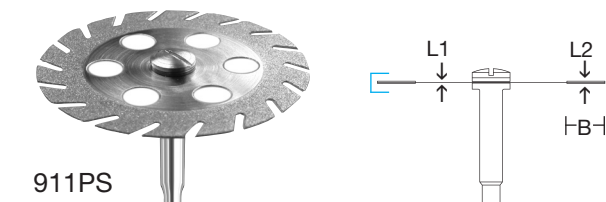

H/HP/PM	911PS/...	300
ISO 806 104 333 524...		
L1		0,21
L2		0,30
B		5,0

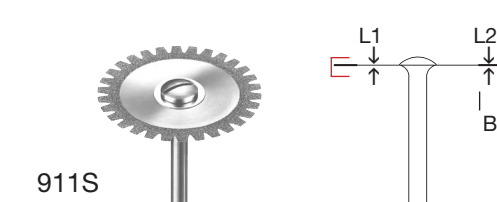

H/HP/PM	911S/...	220
ISO 806 104 365 514...		
L1		0,10
L2		0,27
B		3,4



● 1837



● H/HP/PM	1837/...	031	
ISO 807 104 111 534...			
● H/HP/PM	1837/...		050
ISO 807 104 112 534...			
L mm		8,5	13,0



● 1842R



● H/HP/PM	1842R/...	031	
ISO 807 104 143 534...			
L mm			12,0



● 1881



● H/HP/PM	1881/...	050	
ISO 807 104 143 534...			
L mm			12,0



● 1847



● H/HP/PM	1847/...	031	
ISO 807 104 172 534...			
L mm			8,5



● 1351
3351



● H/HP/PM	1351/...	050	
ISO 807 104 263 534...			
H/HP/PM	3351/...	050	
ISO 807 104 263 524...			
L mm			12,0



● 1856
3856



● H/HP/PM	1856/...	031	
ISO 807 104 198 534...			
H/HP/PM	3856/...	031	
ISO 807 104 198 524...			
L mm			8,5



● 1850
3850



● H/HP/PM	1850/...	031	
ISO 807 104 200 534...			
H/HP/PM	3850/...	031	
ISO 807 104 200 524...			
L mm			12,0



3859



H/HP/PM	3859/...	031	
ISO 807 104 166 524...			
H/HP/PM	3859/...		050
ISO 807 104 161 524...			
L mm		8,5	11,0



3862



H/HP/PM	3862/...	031	
ISO 807 104 284 524...			
L mm			9,0



3801



H/HP/PM	3801/...	018	
ISO 807 104 001 524...			



● 1893



● H/HP/PM	1893/...	050	
ISO 807 104 201 534...			
L mm			16,0



3368



H/HP/PM	3368/...	016	
ISO 807 104 257 524...			
L mm			6,5



● 1941



● H/HP/PM	1941/...	210	
ISO 807 104 327 534...			
L mm			0,45



3818



H/HP/PM	3818/...	080	
ISO 807 104 041 524...			
L mm			0,5



Polierer

Polishers • Polissoirs • Pulidores

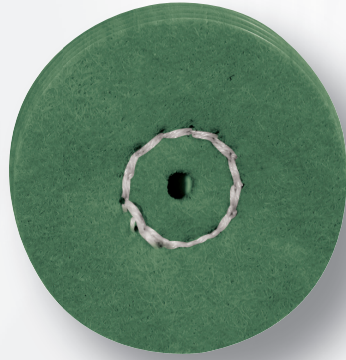

Zahntechnik

Dental Technique • Prothese Dentaire • Protesis Dental

Vorpolierer Pre-polishers Pré-polissoirs pour Pre-pulidores para	72
<hr/>	
2-stufiges Poliersystem für Edelmetall-Legierungen und NEM 2-step polishing system for precious metal alloys and non-precious Système de polissage en 2 étapes pour alliages de métaux précieux et non précieux Sistema de pulimento en 2 etapas para aleaciones de metales preciosos et non-preciosos	73
<hr/>	
Diamantdurchsetzte Schleifkörper für Keramik/Silikatkeramik und Zirkonoxid Diamond interspersed abrasives for ceramics/silicate ceramics and zirconia Abrasifs mélangés des diamants pour la céramique/la céramique silicatée et l'oxyde de zirconie Abrasivos entremezclados con diamantes para cerámica/cerámica de silicatos y dióxido de circonio	74
<hr/>	
Dia-Disc	75
<hr/>	
2-stufiges diamantdurchsetztes Poliersystem für Keramik/Silikatkeramik 2-step diamond interspersed polishing system for ceramics/silicate ceramics Système de polissage en 2 étapes, mélangé des diamants pour la céramique/céramique silicatée Sistema de pulimento en 2 etapas entremezclado con diamantes para cerámica/cerámica de silicatos	76
<hr/>	
2-stufiges diamantdurchsetztes Poliersystem für Zirkonoxid 2-step diamond interspersed polishing system for zirconia Système de polissage en 2 étapes entremêlé des diamants pour l'oxyde de zirconium Sistema de pulimento en 2 etapas entremezclado con diamantes para óxido de circonio	77
<hr/>	
3-stufiges Poliersystem für Kunststoff 3-step polisher system for acrylic Système de polissage en 3 étapes pour acrylique 3 etapas de pulimento para acrílico	78
<hr/>	
SOFT WHEELS, imprägnierte Baumwollschwabbel für Metalle SOFT WHEELS; impregnated buffs for metals SOFT WHEELS, meulette coton imprégnée pour métaux SOFT WHEELS, discos de algodón impregnados para pulir metales	79
<hr/>	
Schwabbel Polishing buffs Disques à polir Discos de trapos	80
<hr/>	
Bürsten Brushes Brosses Cepillos	81
<hr/>	

**Vorpolitur alle
Werkstoffe, weiß**

Siliziumkarbid (SiC), Silikon
Korngröße grob
Bindungshärte weich

**pre-polishing for all
materials, white**

silicon carbide (SiC), Silicone
grit size coarse
bond hardness soft

**pre-polishing pour
tous matériels, blanc**

carbure de silicium (SiC),
silicone
taille de grain gros
dureté de liaison doux

**prepulimento para todos
los materiales, blanco**

carburo de silicio (SiC),silicona
tamaño de grano grueso
dureza de la ligazón blanda

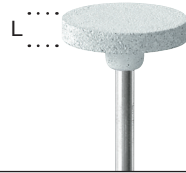

H/HP/PM ISO 658 104 ...	9702G/145 044 532 145	9706G/055 257 532 055
L mm	2,50	15,00

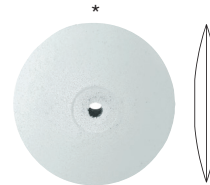
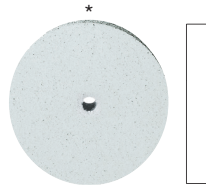

Unmontiert / unmounted / non-monté / sin montar ISO 658 900 ...	9602G/220 372 532 220	9603G/220 303 532 220
L mm	030	040

**Vorpolitur Modellguß-
legierungen, CrCo,
mocca**

Siliziumkarbid (SiC), PUR
Korngröße mittel
Bindungshärte hart

**pre-polishing for model
casting, CrCo,
mocha**

silicon carbide (SiC), PUR
grit size medium
bond hardness medium

**prépolissage pour
stellite, CrCo,
mocca**

carbure de silicium (SiC), PUR
taille de grain moyen
dureté de liaison moyen

**prepulimento para alea-
ciones de colados, CrCo,
moca**

carburo de silicio (SiC), PUR
tamaño de grano medio
dureza de la ligazón media

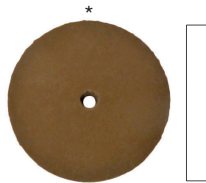

*Besonders hohe Standzeit!
Very high endurance!
Durabilité prolongée!
Duración muy larga!*



Unmontiert / unmounted / non-monté / sin montar ISO 653 900	9660/220 372 524 220
L mm	3,00



L = Arbeitsteillänge mm/working part length mm/longueur de la partie travaillante mm/longitud de la parte de fresado mm

* Träger siehe Seite 101/mandrels see page 101/mandrins voir page 101/mandriles vea página 101



Politur, braun

Siliziumkarbid (SiC), PUR
Korngröße mittel
Bindungshärte mittel

polishing, brown

silicon carbide (SiC), PUR
grit size medium
bond hardness medium

polissage, marron

carbure de silicium (SiC), PUR
Taille de grain moyen
dureté de liaison moyen

pulimento, marrón

carburo de silicio (SiC), PUR
Tamaño de grano medio
dureza de la ligazón media



H/HP/PM ISO 653 104 ...	9702/145 044 523 145	9706/055 257 523 055	9704/050 292 523 050
L mm	2,00	18,00	16,00

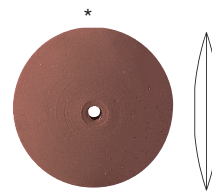
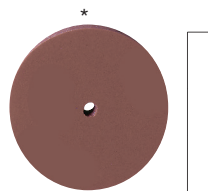

Unmontiert / unmounted / non-monté / sin montar ISO 653 ...	9602/220 900 372 523 220	9603/220 900 303 523 220	9605/030 000 114 523 030
L mm	3,00	4,00	23,00

Endpolitur, grün

Siliziumkarbid (SiC), PUR
Korngröße fein
Bindungshärte weich

end polishing, green

silicon carbide (SiC), PUR
grit size fine
bond hardness soft

polissage final, vert

carbure de silicium (SiC), PUR
taille de grain fin
dureté de liaison doux

pulimento final, verde

carburo de silicio (SiC), PUR
tamaño de grano fino
dureza de la ligazón blanda

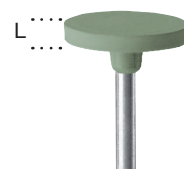

H/HP/PM ISO 653 104 ...	9712/145 044 512 145	9716/055 257 512 055
L mm	2,00	18,00

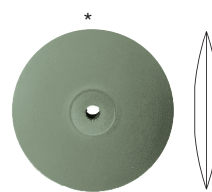
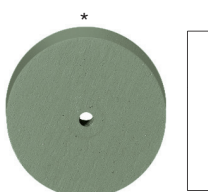

Unmontiert / unmounted / non-monté / sin montar ISO 653 ...	9612/220 900 372 512 220	9613/220 900 303 512 220	9615/030 000 114 512 030
L mm	3,00	4,00	23,00

L = Arbeitsteillänge mm/working part length mm/longueur de la partie travaillante mm/longitud de la parte de fresado mm

* Träger siehe Seite 101/mandrels see page 101/mandrins voir page 101/mandriles vea página 101

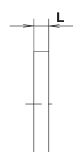



Diamantdurchsetzte Schleifkörper für Keramik/Silikatkeramik und Zirkonoxid

Diamond interspersed abrasives for ceramics/silicate ceramics and zirconia

Abrasifs mélangés des diamants pour la céramique/la céramique silicatée et l'oxyde de zircon

Abrasivos entremezclados con diamantes para cerámica/cerámica de silicatos y dióxido de circonio

Formschleifen, grau grün

Diamant, synthetisch gebunden
Korngröße grob
Bindungshärte x-hart

moulding, grey green

diamond, synthetic bond
grit size coarse
bond hardness x-hard

meulage façonné, gris vert

diamant, liaison synthétique
taille de grain gros
dureté de liaison x-dur

rectificado, gris verde

diamante, ligar sintética
tamaño de grano grueso
dureza de la ligazón extra dura



H/HP/PM ISO 803 104 ...	D712/120 044 535 120	D733/040 173 535 040	D732/050 113 535 050
L mm	2,00	10,00	13,00



diamantdurchsetzt/diamond interspersed/entremêlé des diamants/entremezclado con diamantes



Hochflexible, diamantdurchsetzte Kunststoffscheiben zum Vorschleifen oder Feinschleifen von Keramik und Komposit

Diamant, Kunststoffbindung montiert

a high flexible interspersed diamond synthetic disc for pre-grinding and moulding ceramics and composites

diamond, acrylic bond mounted

disque synthétique entremêlé des diamants, extrêmement flexible, pour le prépolissage et modelage de la céramique et des composites

diamant, liaison résine monté

un disco sintético entremezclado con diamantes de extrema flexibilidad para prepulimento y correcciones de cerámica y composites

diamante, ligazón acrílico montado

Vorschleifen, dunkelgrün

Korngröße grob

pre-grinding, dark green

grit size coarse

prépolissage, vert foncé

taille de grain gros

prepulimento, verde oscuro

tamaño de grano grueso

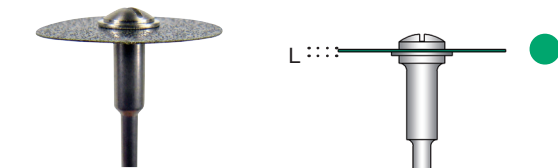

H/HP/PM ISO 803 104 ...	9690G/220 354 534 220
L mm	0,30

Feinschleifen, ziegel

Korngröße mittel

fine-grinding, brick coloured

grit size medium

polissage fin, brique

taille de grain moyen

pulimento fino, ladrillo

tamaño de grano medio

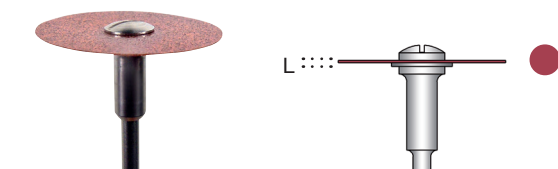

H/HP/PM ISO 803 104 ...	9690M/220 354 524 220
L mm	0,25



diamantdurchsetzt/diamond interspersed/entremêlé des diamants/entremezclado con diamantes



2-stufiges diamantdurchsetztes Poliersystem für Keramik/Silikatkeramik

2-step diamond interspersed polishing system for ceramics/silicate ceramics

Système de polissage en 2 étapes, mélangé des diamants pour la céramique/céramique silicatée

Sistema de pulimento en 2 etapas entremezclado con diamantes para cerámica/cerámica de silicatos

Politur, rot gelb

Diamant, PUR
Korngröße mittel
Bindungshärte mittel

polishing, red yellow

diamant, PUR
grit size medium
bond hardness medium

polissage, rouge jaune

diamant, PUR
taille de grain moyen
dureté de liaison moyen

pulimento, rojo amarillo

diamante, PUR
tamaño de grano medio
dureza de la ligazón media

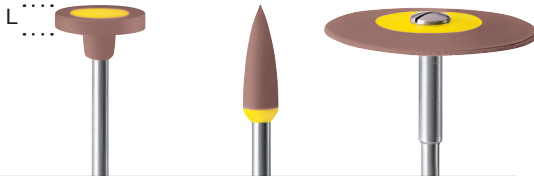

H/HP/PM ISO 803 104 ...	9952/110 044 523 110	9954/040 257 523 040	9953/260 303 523 260
L mm	2,00	13,00	2,00

Endpolitur, grün gelb

Diamant, PUR
Korngröße fein
Bindungshärte mittel

end-polishing, green yellow

diamond, PUR
grit size fine
bond hardness medium

polissage final, vert jaune

diamant, PUR
taille de grain fin
dureté de liaison moyen

pulimento final, verde amarillo

diamante, PUR
tamaño de grano fino
dureza de la ligazón media

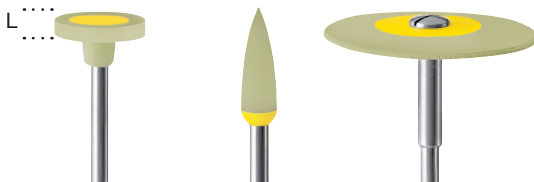

H/HP/PM ISO 803 104 ...	9962/110 303 513 260	9964/040 257 513 040	9963/260 044 513 110
L mm	2,00	13,00	2,00



diamantdurchsetzt/diamond interspersed/entremêlé des diamants/entremezclado con diamantes



2-stufiges diamantdurchsetztes Poliersystem für Zirkonoxid
 2-step diamond interspersed polishing system for zirconia
 Système de polissage en 2 étapes entremêlé des diam. pour l'oxyde de zirconium
 Sistema de pulimento en 2 etapas entremezclado con diamantes para óxido de circonio



Politur, türkis gelb

Diamant, PUR
 Korngröße mittel
 Bindungshärte hart

polishing, turquoise yellow

diamant, PUR
 grit size medium
 bond hardness hard

polissage, turquois jaune

diamant, PUR
 taille de grain moyen
 dureté de liaison dure

pulimento, turquesa amarillo

diamante, PUR
 tamaño de grano media
 dureza de la ligazón dura

H/HP/PM ISO 803 104 ...	9852/110 044 524 110	9854/040 257 524 040	9853/260 303 524 260
L mm	2,00	13,00	2,00

Endpolitur, rosa gelb

Diamant, PUR
 Korngröße fein
 Bindungshärte hart

end-polishing, pink yellow

diamond, PUR
 size fine
 bond hardness hard

polissage final, rose jaune

diamant, PUR
 taille de grain fin
 dureté de liaison dure

pulimento final, rosa amarillo

diamante, PUR
 tamaño de grano fino
 dureza de la ligazón dura

H/HP/PM ISO 803 104 ...	9862/110 044 514 110	9864/040 257 514 040	9863/260 303 514 260
L mm	2,00	13,00	2,00



diamantdurchsetzt/diamond interspersed/entremêlé des diamants/entremezclado con diamantes

Glätten, grün

Siliziumkarbid (SiC), Silikon
 Korngröße grob
 Bindungshärte mittel

smoothing, green

silicon carbide (SiC), silicone
 grit size coarse
 bond hardness medium

lissage, vert

carbure de silicium (SiC), silicone
 taille de grain gros
 dureté de liaison moyenne

alisado, verde

carburo de silicio (SiC), silicona
 tamaño de grano grueso
 dureza de la ligazón media



H/HP/PM ISO 658 104 ...	9626G/055 284 533 055	9626G/100 251 533 100	9626G/120 251 533 120	9628G/065 497 533 065	9628G/100 497 533 100
L mm	16,00	20,00	22,00	17,00	24,00

Politur, anthrazit

Siliziumkarbid (SiC), Silikon
 Korngröße mittel
 Bindungshärte mittel

polishing, anthrazite

silicon carbide (SiC), silicone
 grit size medium
 bond hardness medium

polissage, anthrazite

carbure de silicium (SiC), silicone
 taille de grain moyen
 dureté de liaison moyenne

pulimento, antracita

carburo de silicio (SiC), silicona
 tamaño de grano medio
 dureza de la ligazón media



H/HP/PM ISO 658 104 ...	9626/055 284 523 055	9626/100 251 523 100	9626/120 251 523 120	9628/065 497 523 065	9628/100 497 523 100
L mm	16,00	20,00	22,00	17,00	24,00

Endpolitur, khaki

Siliziumkarbid (SiC), Silikon
 Korngröße fein
 Bindungshärte mittel

end-polishing, khaki

silicon carbide (SiC), Silicone
 grit size fine
 bond hardness medium

polissage final, kaki

carbure de silicium (SiC), silicone
 taille de grain fin
 dureté de liaison moyenne

pulimento final, caqui

carburo de silicio (SiC), silicona
 tamaño de grano fino
 dureza de la ligazón media



H/HP/PM ISO 658 104 ...	9622/055 284 513 055	9622/100 251 513 100	9622/120 251 513 100	9624/065 497 513 060	9624/100 497 513 100
L mm	16,00	20,00	22,00	17,00	24,00

SOFT WHEELS, imprägnierte Baumwollschwabbel für Metalle
 SOFT WHEELS, impregnated buffs for metals
 SOFT WHEELS, meulettes coton imprégnées pour métaux
 SOFT WHEELS, discos de algodón impregnados para pulir metales



Baumwollschwabbel imprägniert (Einsatz ohne Polierpaste)
 impregnated cotton buffs (application without polishing paste)
 meulettes coton imprégnées (utilisation sans pâte à polir)
 discos de algodón impregnados (sin uso de pasta para pulir)

Vorpolitur, grün

Edelkorund (Al₂O₃)
 Korngröße mittel

pre-polishing, green

high-grade corundum (Al₂O₃)
 grit size medium

prépolissage, vert

corindon affiné (Al₂O₃)
 taille de grain moyen

prepulimento, verde

corindon fino (Al₂O₃)
 tamaño de grano medio

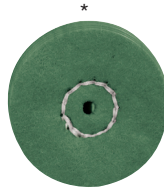

Unmontiert / unmounted / non-monté / sin montar ISO 010 900 ...	9544M/220 372 521 220
L mm	3,00

Glanzpolitur, pink

Edelkorund (Al₂O₃)
 Korngröße extra fein

high-lustre polishing, pink

high-grade corundum (Al₂O₃)
 grit size extra fine

polissage brillant, rose

corindon affiné (Al₂O₃)
 taille de grain extra fin

pulimento brillo, fucsia

corindon fino (Al₂O₃)
 tamaño de grano extra fino



Unmontiert / unmounted / non-monté / sin montar ISO 010 900 ...	9544F/220 372 501 220
L mm	3,00

* Träger siehe Seite 101/mandrels see page 101/mandrins voir page 101/mandriles vea página 101

für Hochglanzpolitur
mit Diamantpaste

Cambric, feiner Nesselstoff

for high-lustre polishing
with diamond paste

cambric, fine nettle cloth

für Hochglanzpolitur
nach dem Pasteneinsatz

Wildleder

for high-lustre polishing
after the use of paste

suede

pour le polissage
spéculaire avec la
pâte de diamants

cambrai, mousseline

para el pulimento de
alto brillo con pastas
de diamante

cambrayón, fino

pour le polissage
spéculaire après
l'utilisation de la pâte

suède

para el pulimento de
alto brillo tras la
utilización de pastas

gamuza



Unmontiert/unmounted/
non-monté/sin montar

9641/220

ISO

050 900 373 000 220

Unmontiert/unmounted/
non-monté/sin montar

9642/220

ISO

040 900 373 000 220

Bohrung Ø 1,7 mm/Ø of centre hole 1,7 mm/alésage Ø 1,7 mm/perforación Ø 1,7 mm

für abschließende
Hochglanzpolitur nach
dem Pasteneinsatz

Baumwolle
cotton
coton
algodón

for the final high-lustre
polishing after the use
of paste

pour le polissage spé-
culaire de finition après
l'utilisation de la pâte

para el pulimento de alto
brillo de acabado tras la
utilización de pastas



Microfaser
microfiber
microfibre
micro fibra



Montiert/mounted
monté/montado



Unmontiert/unmounted/
non-monté/sin montar

9643/220

ISO

050 900 373 000 220

H/HP/PM

9644/250

Bohrung Ø 1,7 mm/Ø of centre hole 1,7 mm/alésage Ø 1,7 mm/
perforación Ø 1,7 mm

* Träger siehe Seite 101/mandrels see page 101/mandrins voir page 101/mandriles vea página 101

für die Politur mit
Paste

for the polishing with
paste

pour le polissage
avec la pâte

para el pulimento
con pasta

Chungking, harte Borsten
chungking, hard bristles
chungking, durs
chungking, duras



Pferdehaar, harte Borsten
horsehair, hard bristles
poils de cheval, durs
cerdas de caballo, duras



Unmontiert / unmounted /
non-monté / sin montar
ISO

9636/190
100 900 543 000 190



H/HP/PM
ISO

9736/140
100 104 543 000 140

Bohrung Ø 1,7 mm / Ø of centre hole 1,7 mm /
alésage Ø 1,7 mm / perforacion Ø 1,7 mm

Ziegenhaar, weiche Borsten
goat hair, soft bristles
poils de chèvre, doux
cerdas de cabra, blandas



Unmontiert / unmounted /
non-monté / sin montar
ISO

9638/190
090 900 543 000 190

Bohrung Ø 1,7 mm / Ø of centre hole 1,7 mm /
alésage Ø 1,7 mm / perforacion Ø 1,7 mm

Ziegenhaar, weiche Borsten
goat hair, soft bristles
poils de chèvre, doux
cerdas de cabra, blandas



H/HP/PM
ISO

9738/140
090 104 543 000 140

9738/220
090 104 543 000 220

* Träger siehe Seite 101 / mandrels see page 101 / mandrins voir page 101 / mandriles vea página 101

Schleifkörper

Abrasives • Abrasifs • Abrasivos



Zahntechnik

Dental Technique • Prothese Dentaire • Protesis Dental

Schleifkörper für Keramik, Kunststoffe, Metall-Legierungen, CERA-PLUS Schleifkörper und ALOX Schleifkörper Abrasives for ceramic, acrylics, metal alloys, CERA-PLUS abrasives et ALOX abrasives Abrasisifs pour céramique, acrylique, alliages métalliques, Abrasisifs CERA-PLUS et abrasifs ALOX Abrasivos para cerámica, acrílico, aleaciones metálicas, Abrasivos CERA-PLUS y abrasivos ALOX	84+85
Schleifkörper für mittelharte und weiche Metall-Legierungen Abrasives for medium hard metal and soft alloys Abrasisifs pour alliages métalliques moyen-durs et doux Abrasivos para aleaciones metálicas media duras y blandas	86+87
Schleifräder Abrasive wheels Meules abrasives Ruedas abrasivas	88-91
Trennscheiben Separating discs Disques à séparer Discos para separar	92

für Keramik/
Silikatkeramik und
Zirkonoxid

Diamant, grau grün
synthetisch gebunden
Korngröße grob
Bindungshärte x-hard
Formschleifen

for ceramics/silicate
ceramics and zirconia

diamond, grey green
synthetic bond
grit size coarse
bond hardness x-hard
moulding

pour la céramique/la
céramique silicatée et
l'oxyde de zircon

diamant, gris vert
liaison synthétique
taille de grain gros
dureté de liaison x-dur
meulage façonné

para cerámica/cerámica
de silicatos y dióxido de
zirconio

diamante, gris verde
ligar sintética
tamaño de grano grueso
dureza de la ligazón extra dura
rectificado



diamantdurchsetzt
diamond interspersed
entremêlé des diamants
entremezclado con diamantes

H/HP/PM ISO 803 104 ...	D712/120 044 535 120	D733/040 173 535 040	D732/050 113 535 050
L mm	2,00	10,00	13,00

CERA-PLUS Schleifkörper/CERA-PLUS abrasives/Abrasifs CERA-PLUS/Abrasivos CERA-PLUS

für Keramik

Siliziumkarbid
Schleifkörper (SiC), grün
Keramische Bindung
Korngröße fein
Bindungshärte mittel

for ceramics

silicon carbide abrasives
(SiC), green
ceramic bond
grit size fine
bonding hardness medium

pour céramique

abrasifs en carbure
de silicium (SiC), vert
liaison céramique
taille de grain fin
dureté de liaison moyenne

para cerámica

abrasivos de carburo
de silicio (SiC), verde
ligazón cerámica
tamaño de grano fino
dureza de la ligazón media

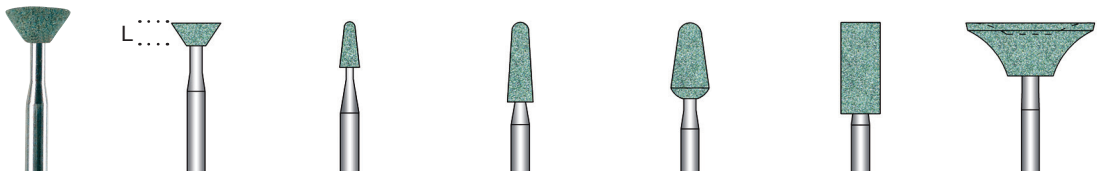

H/HP/PM ISO 655 104 ...	CP613/065 014 512 065	CP649R/025 197 512 025	CP652R/033 199 512 033	CP671/050 260 512 050	CP732/050 107 512 050	CP728/170 023 512 170
L mm	3,00	6,00	10,50	10,00	12,00	7,00

für Keramik, Kunststoffe,
Metall-Legierungen

Siliziumkarbid
Schleifkörper (SiC), grün
Keramische Bindung
Korngröße mittel
Bindungshärte mittel

for ceramic, acrylics,
metal alloys

silicon carbide
abrasives (SiC), green
ceramic bond
Grit size medium
bonding hardness medium

pour céramique, acrylique,
alliages métalliques



abrasifs en carbure
de silicium (SiC), vert
liaison céramique
taille de grain moyenne
dureté de liaison moyenne

para cerámica, acrílico,
aleaciones metálicas

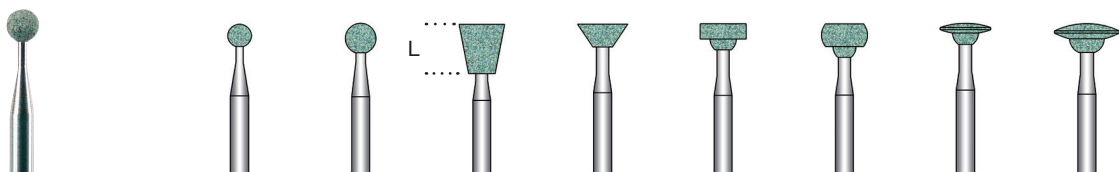

abrasivos de carburo
de silicio (SiC), verde
ligazón cerámica
tamaño de grano medio
dureza de la ligazón media

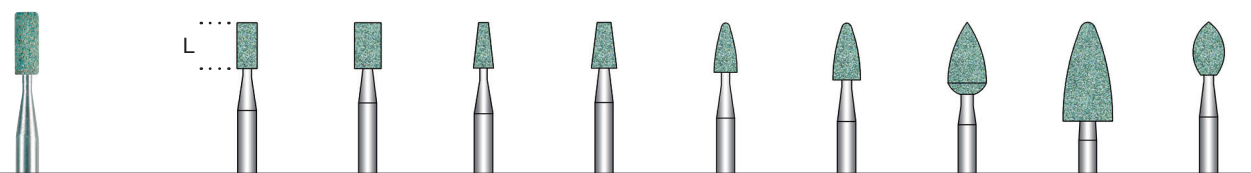

H/HP/PM ISO 655 104 ...	601/030 001 523 030	602/040 001 523 040	609/060 001 523 060	613/065 014 523 065	622/060 042 523 060	628/060 069 523 060	632/065 304 523 065	633/085 304 523 085
L mm	-	-	6,50	3,00	3,40	4,40	2,80	3,80

H/HP/PM ISO 655 104 ...	637/025 110 523 025	639/035 110 523 035	649/025 171 523 025	651/033 171 523 033	661/030 243 523 030	662/035 243 523 035	663/050 243 523 050	665/065 273 523 065	667/040 257 523 040
L mm	6,00	6,00	6,00	6,00	6,50	7,50	9,50	13,00	7,00

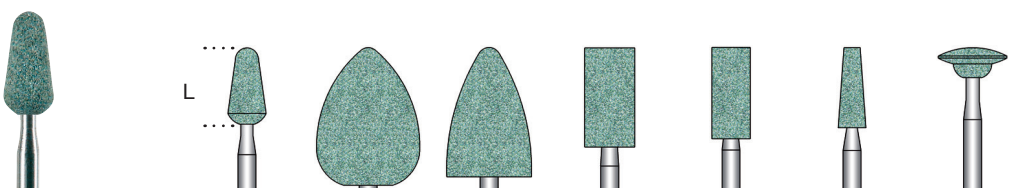
H/HP/PM ISO 655 104 ...	671/050 260 523 050	743/135 254 523 135	744/110 273 523 110	731/065 107 523 065	732/050 107 523 050	733/035 168 523 035	734/090 316 523 090
L mm	10,00	18,00	17,00	13,00	12,00	10,50	3,90

ALOX Schleifkörper/ALOX abrasives/Abrasifs ALOX/Abrasivos ALOX

für edelmetallreduzierte
 und edelmetalfreie
 Metalle

Edelkorund Schleifkörper
 (Al₂O₃), blau
 Keramische Bindung
 Korngröße mittel
 Bindungshärte mittel

for semi-precious
 and
 non-precious metals



high-grade corundum
 abrasives (Al₂O₃), blue
 ceramic bond
 grit size medium
 bonding hardness medium

pour alliages
 semi-précieux et
 non-précieux

abrasifs en corindon
 affiné (Al₂O₃), bleu
 liaison céramique
 taille de grain moyen
 dureté de liaison moyenne

para aleaciones
 semi-preciosas y
 no-preciosas

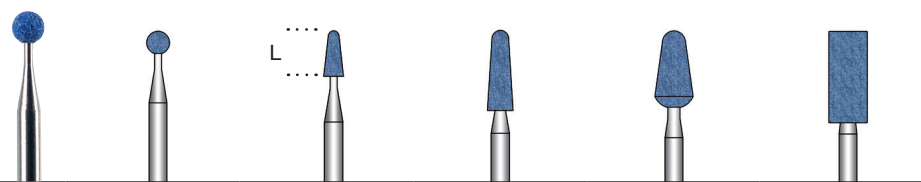
abrasivos de corindon fino
 (Al₂O₃), azul
 ligazón cerámica
 tamaño de grano medio
 dureza de la ligazón media

H/HP/PM ISO 635 104 ...	B601/030 001 523 030	B649R/025 197 523 025	B652R/033 199 523 033	B671/050 260 523 050	B732/050 107 523 050
L mm	-	6,00	10,50	10,00	12,00

für mittelharte Metall-Legierungen

Edelkorund Schleifkörper
(Al₂O₃), rosaKeramische Bindung
Korngröße mittel
Bindungshärte mittel

for medium hard metal alloys

high-grade corundum
abrasives (Al₂O₃), pinkceramic bond
grit size medium
bonding hardness medium

pour alliages métalliques moyen-durs

abrasifs en corindon
affiné (Al₂O₃), roseliaison céramique
taille de grain moyen
dureté de liaison moyenne

para aleaciones metálicas media duras

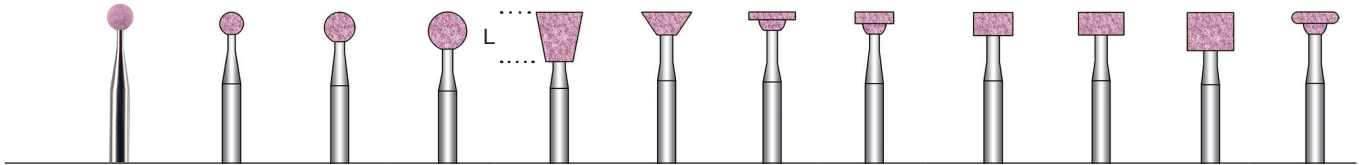
abrasivos de corindon
fino (Al₂O₃), rosaligazón cerámica
tamaño de grano medio
dureza de la ligazón media

H/HP/PM ISO 625 104 ...	601/030 001 523 030	602/040 001 523 040	603/050 012 523 050	609/060 012 512 060	613/065 014 523 065	621/060 041 523 060	619/050 045 230 050	620/050 043 523 050	623/060 043 523 060	624/060 109 523 060	627/060 068 523 060
L mm	-	-	-	6,50	3,00	2,40	2,90	3,00	3,00	5,00	2,90

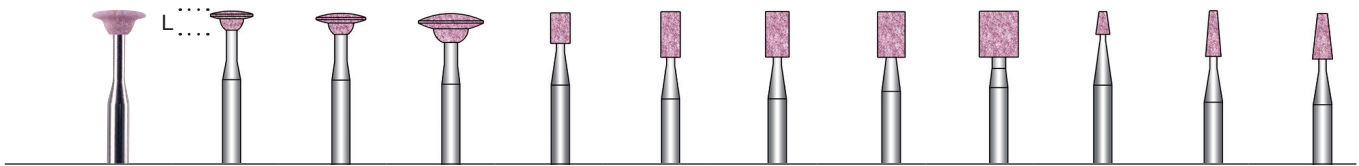

H/HP/PM ISO 625 104 ...	631/055 304 523 055	632/065 304 523 065	633/085 304 523 085	636/025 109 523 025	637/025 110 523 025	638/030 110 523 030	639/035 110 523 035	640/050 110 523 050	646/018 169 523 018	648/020 171 523 020	649/025 171 523 025
L mm	2,50	2,80	3,90	4,00	6,00	6,00	6,00	6,00	3,00	6,00	6,00

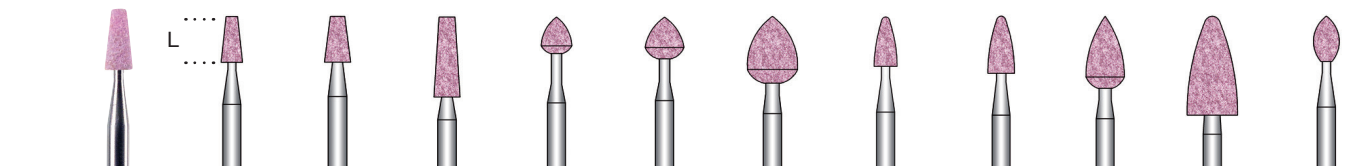

H/HP/PM ISO 625 104 ...	650/028 171 523 028	651/033 171 523 033	652/033 173 523 033	656/040 254 523 040	657/050 254 523 050	658/065 254 523 065	661/030 243 523 030	662/035 243 523 035	663/050 243 523 050	665/065 273 523 065	666/033 257 523 033
L mm	6,00	6,00	10,50	4,80	5,50	8,80	6,50	7,50	9,50	13,00	6,00

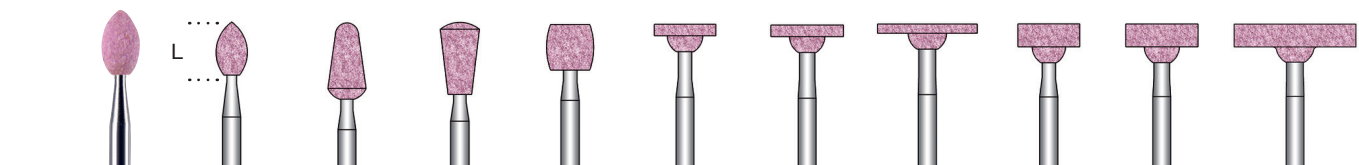

H/HP/PM ISO 625 104 ...	667/040 257 523 040	671/050 260 523 050	677/050 237 523 050	682/060 280 523 060	701/080 041 523 080	702/095 041 523 095	703/130 041 523 130	711/080 042 523 080	712/095 042 523 095	716/160 372 523 160
L mm	7,00	10,00	9,50	6,00	3,60	3,60	3,30	5,10	5,10	5,00

für mittelharte Metall-Legierungen

Edelkorund Schleifkörper (Al₂O₃), rosa
 Keramische Bindung
 Korngröße mittel
 Bindungshärte mittel

for medium hard metal alloys

high-grade corundum abrasives (Al₂O₃), pink
 ceramic bond
 grit size medium
 bonding hardness medium

pour alliages métalliques moyen-durs

abrasifs en corindon affiné (Al₂O₃), rose
 liaison céramique
 taille de grain moyen
 dureté de liaison moyenne

para aleaciones metálicas media duras

abrasivos de corindon fino (Al₂O₃), rosa
 ligazón cerámica
 tamaño de grano medio
 dureza de la ligazón media

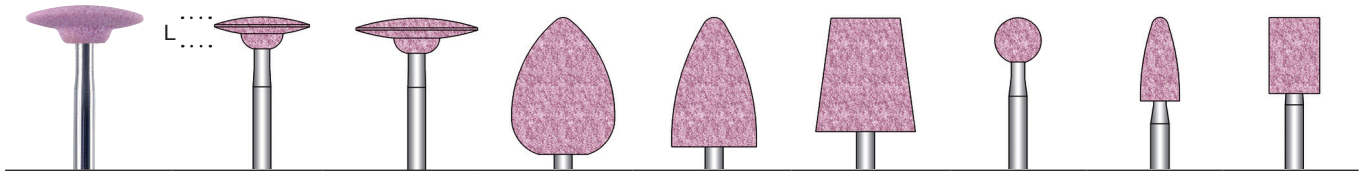

H/HP/PM ISO 625 104 ...	721/125 304 523 125	722/160 304 523 160	743/135 254 523 135	744/110 273 523 110	749/130 175 523 130	755/060 001 523 060	759/050 273 523 050	760/065 112 523 065
L mm	4,20	4,60	18,00	17,00	15,00	-	11,00	10,00

für Chrom-Kobalt

Edelkorund Schleifkörper (Al₂O₃), rosa
 Keramische Bindung
 Korngröße mittel
 Bindungshärte mittel

for chrome-cobalt

high-grade corundum abrasives (Al₂O₃), pink
 ceramic bond
 grit size medium
 bonding hardness medium

pour chrome-cobalt

abrasifs en corindon affiné (Al₂O₃), rose
 liaison céramique
 taille de grain moyen
 dureté de liaison moyenne

para cromo-cobalto

abrasivos de corindon fino (Al₂O₃), rosa
 ligazón cerámica
 tamaño de grano medio
 dureza de la ligazón media

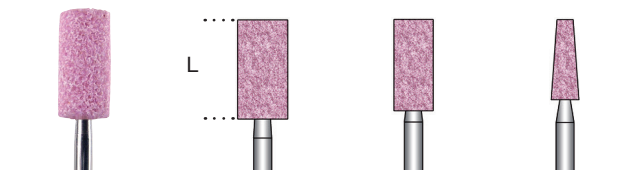

H/HP/PM ISO 625 104 ...	731/065 107 523 065	732/050 107 523 050	733/035 168 523 035
L mm	13,00	12,00	10,50

für weiche Metall-Legierungen

Edelkorund Schleifkörper (Al₂O₃), weiß
 Keramische Bindung
 Korngröße mittel
 Bindungshärte hart
 Niedrige bis mittlere Umdrehungszahlen

for soft metal alloys

high-grade corundum abrasives (Al₂O₃), white
 ceramic bond
 grit size medium
 bonding hardness hard
 low to medium speed

pour alliages métalliques doux

abrasifs en corindon affiné (Al₂O₃), blanc
 liaison céramique
 taille de grain moyen
 dureté de liaison dure
 vitesse basse à vitesse moyenne

para aleaciones metálicas blandas

abrasivos de corindon fino (Al₂O₃), blanda
 ligazón cerámica
 tamaño de grano medio
 dureza de la ligazón dura
 entre revoluciones bajas y medias

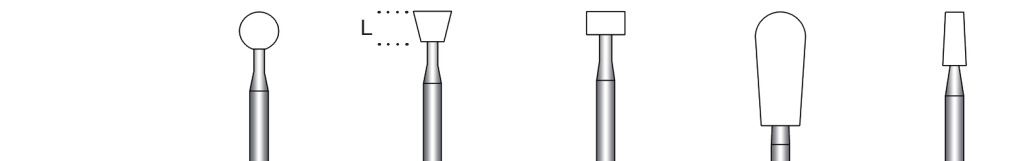

H/HP/PM ISO 625 104 ...	603/050 001 524 050	607/050 012 524 050	620/050 043 524 050	745/065 237 524 065	737/030 168 524 030
L mm	-	4,00	3,00	15,00	7,00

für kühles, trockenes Schleifen von Keramik und Metall-Legierungen

Siliziumkarbid Schleifräder (SiC)
Magnesitbindung
Unmontiert
Bohrung Ø 1,8 mm
Stärke 2,0/3,0/4,5 mm
Korngröße mittel
Bindungshärte weich
Trocken schleifen, nicht desinfizieren oder sterilisieren; trocken lagern

for heatless and dry grinding of ceramics and metal alloys

silicon carbide abrasive wheels (SiC)
magnesite bond
unmounted
Ø of centre hole 1,8 mm
thickness 2,0/3,0/4,5 mm
grit size medium
bonding hardness soft
dry grinding, no disinfection, no sterilization; dry storage

pour le meulage froid et sec de céramique et alliages métalliques

meules abrasives en carbure de silicium (SiC)
liaison magnésite
non-monté
alésage Ø 1,8 mm
épaisseur 2,0/3,0/4,5 mm
taille de grain moyen
dureté de liaison douce
meuler au sec, ni désinfecter, ni stériliser; stocker au sec

esmerilar frío y seco cerámica y aleaciones metálicas

ruedas abrasivas de carburo de silicio (SiC)
ligazón magnesita
sin montar
agujero Ø 1,8 mm
espesor 2,0/3,0/4,5 mm
tamaño de grano medio
dureza de la ligazón blanda
esmerilar en seco, ni desinfectar, ni esterilizar; almacenar en seco

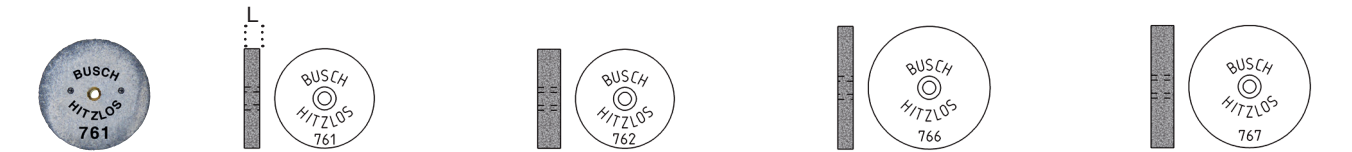

ISO 654 900 ...	761/130 371 522 130	762/130 372 522 130	766/160 371 522 160	767/160 372 522 160
L mm	2,00	3,00	2,00	3,00

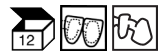
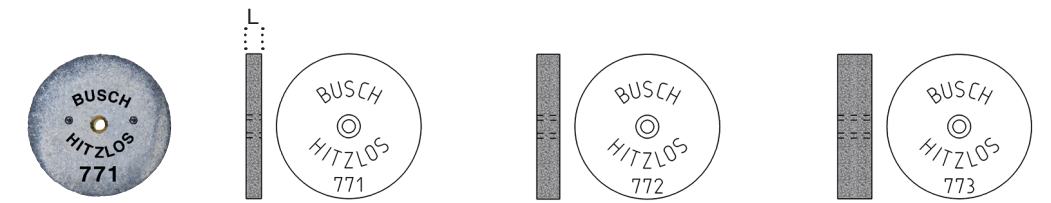

ISO 654 900 ...	771/190 371 522 190	772/190 372 522 190	773/190 373 522 190
L mm	2,00	3,00	4,50

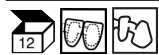
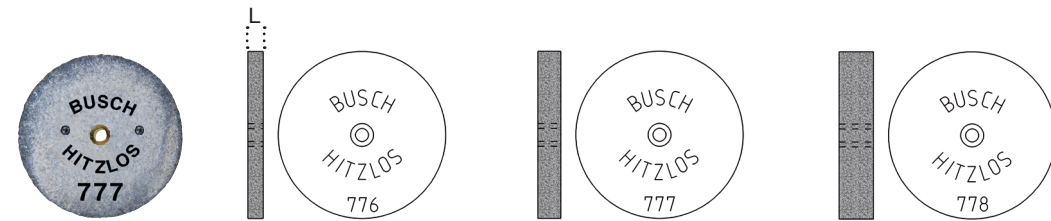

ISO 654 900 ...	776/220 371 522 220	777/220 372 522 220	778/220 373 522 220
L mm	2,00	3,00	4,50

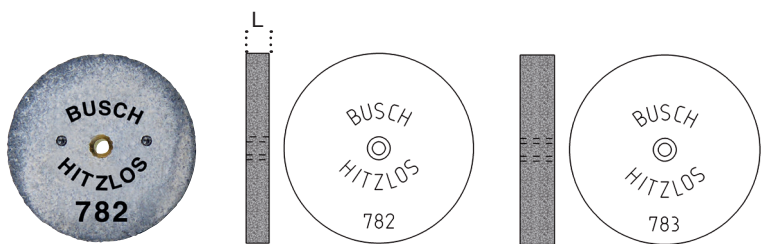

ISO 654 900 ...	782/250 372 522 250	783/250 373 522 250
L mm	3,00	4,50

Träger siehe Seite 101/mandrels see page 101/
mandrins voir page 101/mandriles vea página 101

für feinstes Schleifen
 von Keramik und
 Metall-Legierungen

Siliziumkarbid
 Schleifräder (SiC)
 Magnesitbindung
 Unmontiert
 Bohrung Ø 1,8 mm
 Stärke 2,0/3,0/4,5 mm
 Korngröße fein
 Bindungshärte weich
*Trocken schleifen, nicht
 desinfizieren oder sterilisieren;
 trocken lagern*

for finest grinding
 of ceramics and
 metal alloys

silicon carbide abrasive
 wheels (SiC)
 magnesite bond
 unmounted
 Ø of centre hole 1,8 mm
 thickness 2,0/3,0/4,5 mm
 grit size fine
 bonding hardness soft
*dry grinding, no disinfection,
 no sterilization; dry storage*

pour le meulage très fin
 de céramique et alliages
 métalliques

meules abrasives en
 carbure de silicium (SiC)
 liaison magnésite
 non-monté
 alésage Ø 1,8 mm
 épaisseur 2,0/3,0/4,5 mm
 Taille de grain fin
 dureté de liaison doux
*meuler au sec, ni désinfecter,
 ni stériliser; stocker au sec*

esmerilar de forma fina
 la cerámica y aleaciones
 metálicas

ruedas abrasivas de
 carburo de silicio (SiC)
 ligazón magnesita
 sin montar
 agujero Ø 1,8 mm
 espesor 2,0/3,0/4,5 mm
 tamaño de grano fino
 dureza de la ligazón blanda
*esmerilar en seco, ni
 desinfectar, ni esterilizar;
 almacenar en seco*

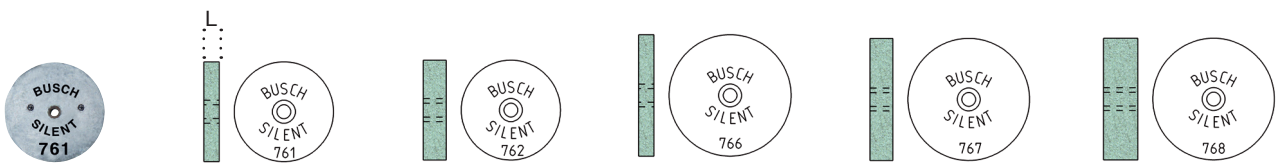

ISO 654 900 ...	761/130 371 512 130	762/130 372 512 130	766/160 371 512 160	767/160 372 512 160	768/160 373 512 160
L mm	2,00	3,00	2,00	3,00	4,50

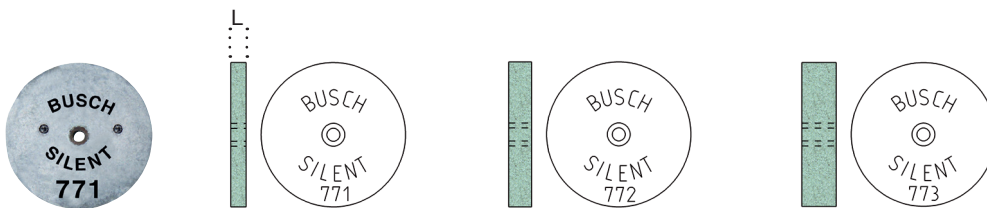

ISO 654 900 ...	771/190 371 512 190	772/190 372 512 190	773/190 373 512 190
L mm	2,00	3,00	4,50

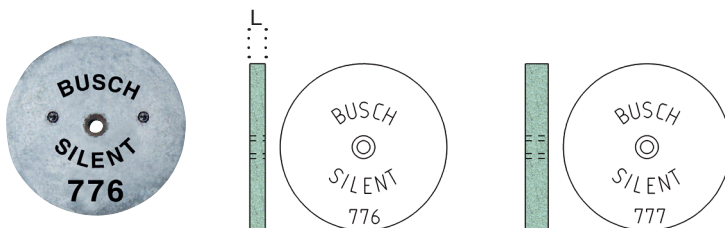

ISO 654 900 ...	776/220 371 512 220	777/220 372 512 220
L mm	2,00	3,00

für Keramik, Metall-Legierungen, Kunststoff

Siliziumkarbid
Schleifräder (SiC), grün
Keramische Bindung
Unmontiert,
Bohrung Ø 1,8 mm
Korngröße mittel
Bindungshärte mittel

for ceramics, acrylics, metal alloys

silicon carbide abrasive
wheels (SiC), green
ceramic bond
unmounted,
Ø of centre hole 1,8 mm
grit size medium
bonding hardness medium

pour céramiques, acrylique, alliages métalliques

meules abrasives en carbure
de silicium (SiC), vert
liaison céramique
non-monté,
alésage Ø 1,8 mm
taille de grain moyen
dureté de liaison moyenne

para cerámica, acrílico, aleaciones metálicas

ruedas abrasivos de carburo
de silicio (SiC), verde
ligazón cerámica
sin montar,
agujero Ø 1,8 mm
tamaño de grano medio
dureza de la ligazón media

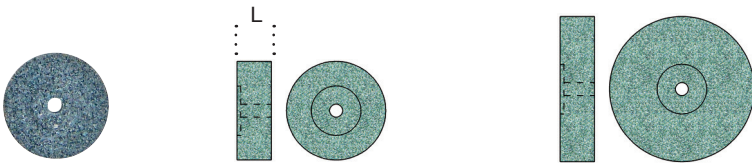

ISO 655 900 ...	763/130 373 523 130	773/190 373 523 190
L mm	4,50	4,50

für Kunststoffe und Metall-Legierungen

Siliziumkarbid
Schleifräder (SiC),
grün
Keramische Bindung
Unmontiert
Bohrung Ø 6,5 mm
Stärke 6,5 mm
Korngröße mittel, grob
Bindungshärte mittel

for acrylics and metal alloys

silicon carbide
abrasive wheels (SiC),
green
ceramic bond
unmounted
Ø of centre hole 6,5 mm
thickness 6,5 mm
grit size medium, coarse
bonding hardness medium

pour résines et alliages métalliques

meules abrasives en
carbure de silicium (SiC),
vert
liaison céramique
non-monté
alésage Ø 6,5 mm
épaisseur 6,5 mm
taille de grain moyen, gros
dureté de liaison moyenne

para acrílico y aleaciones metálicas

ruedas abrasivos de
carburo de silicio (SiC),
verde
ligazón cerámica
sin montar
agujero Ø 6,5 mm
espesor 6,5 mm
tamaño de grano medio,
grosso
dureza de la ligazón media

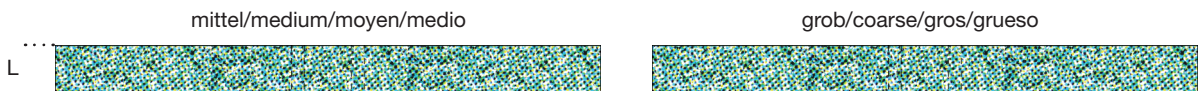
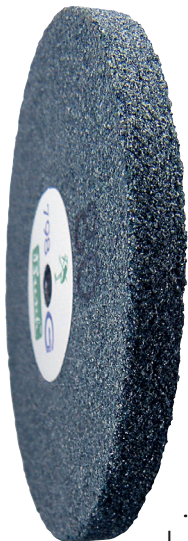

ISO 655 920 ...	798/750 375 523 750	798/750 375 533 750
L mm	6,50	6,50

für mittelharte Metall-Legierungen wie Chrom-Kobalt

Edelkorund Schleifräder (Al₂O₃), rosa
 Keramische Bindung
 Unmontiert
 Bohrung Ø 1,8 mm
 Korngröße mittel
 Bindungshärte mittel

for medium hard metal alloys like chrome-cobalt

high-grade corundum abrasive wheels (Al₂O₃), pink
 ceramic bond
 unmounted
 Ø of centre hole 1,8 mm
 grit size medium
 bonding hardness medium

pour alliages métalliques moyen-durs comme chrome-cobalt

meules abrasives en corindon affiné (Al₂O₃), rose
 liaison céramique non-monté
 alésage Ø 1,8 mm
 taille de grain moyen
 dureté de liaison moyenne

para aleaciones metálicas media-duras como cromo-cobalto

abrasivos de corindon fino (Al₂O₃), rosa
 ligazón cerámica sin montar
 agujero Ø 1,8 mm
 tamaño de grano medio
 dureza de la ligazón media

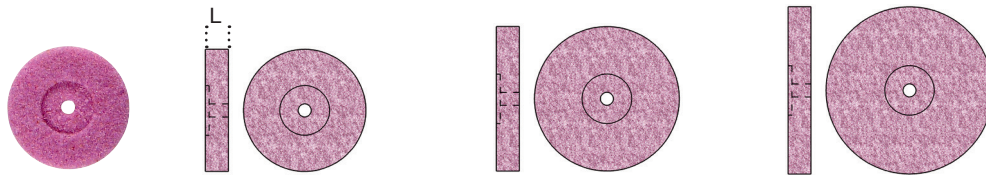

ISO 625 900 ...	767/160 372 523 160	772/190 372 523 190	777/220 372 523 220
L mm	3,00	3,00	3,00

für weiche Metall-Legierungen

Edelkorund Schleifkörper (Al₂O₃), weiß
 Keramische Bindung
 Unmontiert
 Bohrung Ø 1,8 mm
 Korngröße mittel
 Bindungshärte hart

for soft metal alloys

high-grade corundum abrasives (Al₂O₃), white
 ceramic bond
 Unmounted
 Ø of centre hole 1,8 mm
 grit size medium
 bonding hardness hard

pour alliages métalliques doux

abrasifs en corindon affiné (Al₂O₃), blanc
 liaison céramique Non-monté
 alésage Ø 1,8 mm
 taille de grain moyen
 dureté de liaison dure

para aleaciones metálicas blandas

abrasivos de corindon fino (Al₂O₃), blanda
 ligazón cerámica Sin montar
 agujero Ø 1,8 mm
 tamaño de grano medio
 dureza de la ligazón dura

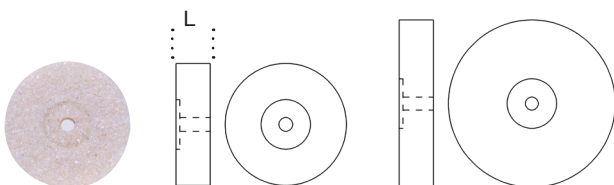

ISO 635 900 ...	768/160 373 524 160	778/220 373 524 220
L mm	4,50	4,50

Träger siehe Seite 101/mandrels see page 101/mandrins voir page 101/mandriles vea página 101

Träger siehe Seite 101/mandrels see page 101/mandrins voir page 101/mandriles vea página 101

**für Chrom-Kobalt
und andere
Metall-Legierungen**

Edelkorund Trennscheiben
(Al₂O₃), braun
Kunstharzbindung
Unmontiert
Bohrung Ø 1,8 mm
Korngröße mittel
Bindungshärte hart

**for chrome-cobalt
and other
metal alloys**

high-grade corundum cutting-
off discs (Al₂O₃), brown
resin bond
unmounted
Ø of centre hole 1,8 mm
grit size medium
bonding hardness hard

**pour chrome-cobalt
et d'autres alliages
métalliques**

disques à séparer en
corindon affiné (Al₂O₃), marron
liaison résine
non-monté
alésage Ø 1,8 mm
taille de grain moyen
dureté de liaison dure

**para cromo-cobalto
y otras aleaciones
metálicas**

discos separadores de
corindon fino (Al₂O₃), marrón
ligazón resina
sin montar
agujero Ø 1,8 mm
tamaño de grano medio
dureza de la ligazón dura



ISO 613 900 ...	435/220 327 524 220	436/220 327 524 220	437/250 371 524 250	437/375 371 524 375
L mm	0,24	0,60	1,00	1,00

für Keramik

Siliziumkarbid
Trennscheiben (SiC), grau
Kunstharzbindung
Unmontiert
Bohrung Ø 1,8 mm
Korngröße mittel
Bindungshärte hart

for ceramics

silicon carbide
separating discs (SiC), grey
resin bond
unmounted
Ø of centre hole 1,8 mm
grit size medium
bonding hardness hard

pour céramiques

disques à separer en carbure
de silicium (SiC), gris
liaison résine
non-monté
alésage Ø 1,8 mm
taille de grain moyen
dureté de liaison dur

para cerámica

discos para separar de carburo
de silicio (SiC), gris
ligazón resina
sin montar
agujero Ø 1,8 mm
tamaño de grano medio
dureza de la ligazón dura

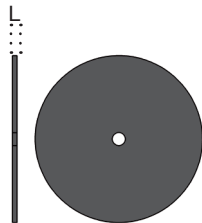

ISO 653 900 ...	436/220 329 524 220
L mm	0,60

Sonstiges

Miscellaneous • Autres • Otros

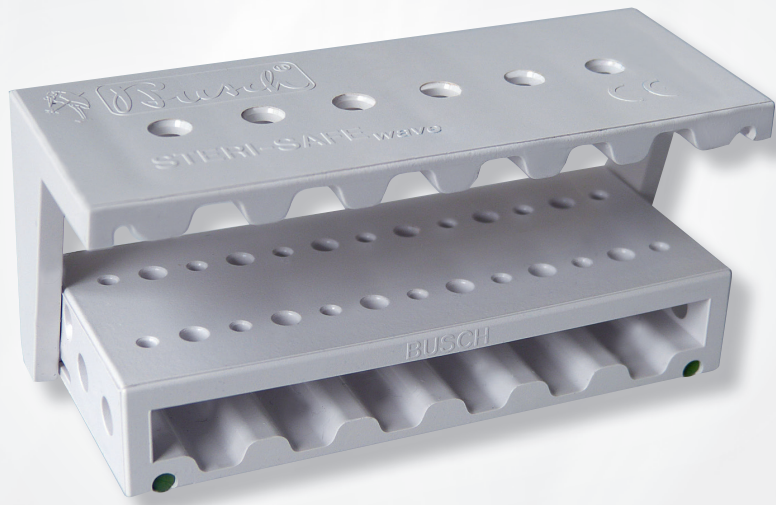

STERI-SAFE 96+97

Bohrerständler, Polierpaste
Bur bloc, polishing paste
Porte-fraises, pâte à polir
Fresero, pasta de pulir 98

EVERCLEAR Mundspiegel, Bohrerlehre
EVERCLEAR mouth mirrors, bur gauge
Miroirs à bouche EVERCLEAR, filière
Espejos de boca EVERLCEAR, calibrador de fresas 99

Keramik Block, Reinigungsstein, Abrichtdiamant
Ceramic block, dressing stone, dressing diamond
Bloque céramique, pierre à déburrer, diamant à dresser
Bloque de cerámica, piedra de limpieza, recortador diamantado 100

Träger
Mandrels
Mandrins
Mandriles 101

Die STERI-SAFE Bohrerständer aus Medical Kunststoff mit den überzeugenden Vorteilen in Anwendung, Sicherheit und Hygiene:

- die offene Konstruktion für eine bessere Durchströmung im Sinne einer optimalen und effektiven Wiederaufbereitung
- der desinfizierbare und sterilisierbare Medical Kunststoff ist für alle praxisrelevanten Wiederaufbereitungsmaßnahmen geeignet
- der präzise schwenk- und arretierbare Sicherheitsbügel für eine leichte Handhabung

The STERI-SAFE bur block of medical resin with outstanding advantages in respect of use, safety and hygiene:

- open design for better flow penetration ensuring optimum and effective reconditioning
- the medical resin material can be disinfected and sterilized with all reconditioning measures of practical relevance
- retaining clip can be precisely swivelled and locked in place for easy handling

Porte-fraises STERI-SAFE en résine médicale avec des avantages convaincants sur le plan de l'utilisation, de la sécurité et de l'hygiène:

- construction ouverte pour une meilleure circulation dans le cadre d'un reconditionnement optimal et efficace
- résine médicale pouvant être désinfectée et stérilisée avec toutes les mesures de reconditionnement dans les cabinets dentaires
- anse de sécurité précise pouvant être orientée et bloquée pour une utilisation aisée

Fresero STERI-SAFE, fabricado en resina medical, con ventajas que convencen en cuanto a aplicación, seguridad e higiene:

- la construcción abierta para un mejor perfusión en el sentido de una reutilización óptima y efectiva
- la resina medical se puede desinfectar y esterilizar con todas los métodos de reutilización relevantes en la práctica
- el arco de seguridad giratorio y bloqueable para un manejo fácil



ultraschallbeständig
resistant to ultrasound
résistant aux ultrasons
resistente para baños de ultrasonido



134°C autoclavierbar bei 134°C
suitable for autoclaving at 134°C
peut être stérilisé dans l'autoclave à 134°C
resistente a autoclave con 134°C



desinfektionsmittelbeständig
resistant to disinfectant
résistant aux désinfectants
resistente a medios de desinfección



thermodesinfektorbeständig
suitable for use in a thermal disinfectant
résistant à la désinfection thermique
resistente para el uso en aparatos de desinfección térmica



180°C heißluftsterilisierbar bei 180°C
can be sterilized in hot air at 180°C
peut être stérilisé à air chaud à 180°C
esterilizable en esterilizadores de aire caliente



EO chemiclavierbar
suitable for chemical autoclaving
peut être stérilisé dans un chemiclave
apropiado para autoclave químico

STERI-SAFE^{pro}

Konzipiert für max. 24 Instrumente mit einer Gesamtlänge von 36 mm bis 56,5 mm
designed for max. 24 instruments with a total length of 36 mm to 56,5 mm
conçu pour max. 24 instruments d'une longueur totale de 36 mm à 56,5 mm
concebido para un máximo de 24 instrumentos con una longitud total entre 36 mm y 56,5 mm

5772+D



STERI-SAFE_{wave}

Besondere Vorteile:

- die Reinigungsfähigkeit inkl. vorkontaminierter Medizinprodukte wurde durch ein externes Institut validiert und dokumentiert

special advantages:

- the cleaning ability - including pre-contaminated medical products - had been validated and documented by an external institute

avantages spéciaux:

- l'aptitude de nettoyage y compris des produits médicaux pré-contaminés a été validée et documentée par un Institut externe

ventajas especiales:

- la capacidad de limpieza del zócalo (incl. productos médicos pre-contaminados) ha sido validado y documentado por un instituto externo



- die kombinierte Aufnahme-kapazität von 14 FG Instrumenten mit einer Gesamtlänge von 19-24 mm und/oder 12 WST Instrumenten mit einer Gesamtlänge von 22-30mm
- die Möglichkeit der Farbkodierung durch Silikonbänder, die zudem einen rutschfesten Stand sichern
- alle Instrumente der aufgeführten Gesamtlängen sind in geschlossenem Zustand gegen Herausfallen geschützt

- combined capacity for accommodating 14 instruments with FG shank with an overall length of 19 – 24 mm and/or 12 instruments with RA shank with an overall length of 22 – 30 mm
- can be colour-coded with silicone strips which additionally enhance the bur block's stability
- all instruments of the listed total lengths are protected against falling out when closed

- rangement simultané de 14 instruments FG d'une longueur totale de 19 à 24 mm et/ou de 12 instruments CA d'une longueur totale de 22 à 30 mm
- Possibilité d'un codage couleur par des traits de silicone qui assurent aussi une stabilité antidéparante
- tous les instruments dans les longueurs mentionnés sont protégés de tomber dans état fermé

- la capacidad de alojamiento combinada de 14 instrumentos FG con una longitud total de 19-24 mm y/o 12 instrumentos CA con una longitud total de 22-30 mm
- la posibilidad de codificación por colores mediante las tiras de silicona, que además garantizan un asiento antideslizante
- todos los instrumentos (con las longitudes totales mencionadas arriba) están protegidas de caer con el arco cerrado

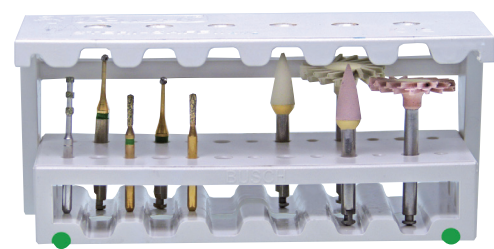
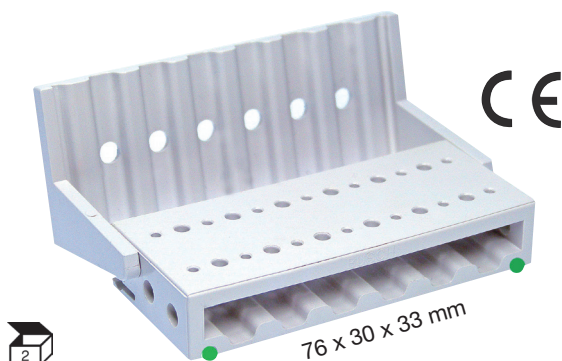

- 5773-01 **STERI-SAFE_{wave} SILIKONBAND ROT**
with silicone strip red, avec trait en silicone rouge, con tiras de silicona rojas
- 5773-02 **STERI-SAFE_{wave} SILIKONBAND GELB**
with silicone strip yellow, avec trait en silicone jaune, con tiras de silicona amarillos
- 5773-03 **STERI-SAFE_{wave} SILIKONBAND GRÜN**
with silicone strip green, avec trait en silicone vert, con tiras de silicona verdes
- 5773-04 **STERI-SAFE_{wave} SILIKONBAND BLAU**
with silicone strip blue, avec trait en silicone bleu, con tiras de silicona azules
- 5773-05 **STERI-SAFE_{wave} SILIKONBAND SCHWARZ**
with silicone strip black, avec trait en silicone noir, con tiras de silicona negras



Ersatz Silikonbänder/spare silicone strips
replacement de traits en silicone/
tiras de silicona de recambio

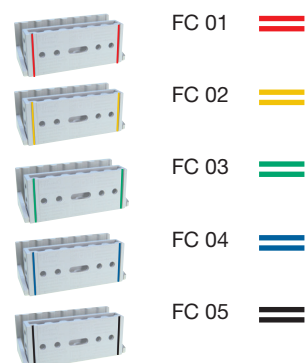

Sonstiges • Bohrerständer, Polierpaste
 Miscellaneous • bur bloc, polishing paste
 Autres • porte-fraises, pâte à polir
 Otros • fresero, pasta de pulir



Socket-System

Material: Polystyrol,
 Farbe: Elfenbein
 Aufnahmemöglichkeit:
Zweifachsocket 5762:
 29 Löcher H/W +
 12 Löcher FG
Vierfachsocket 5764:
 62 Löcher H/W +
 24 Löcher FG

stand-system

material: polystyrene,
 colour: ivory
 possible assortments:
double stand 5762:
 29 holes HP/RA +
 12 holes FG
quadruple stand 5764:
 62 holes HP/RA +
 24 holes FG

système de socles

matériau: polystyrène,
 couleur: Ivoire
 assortiments possibles:
socle double 5762:
 29 orifices PM/CA +
 12 orifices FG
socle quadruple 5764:
 62 orifices PM/CA +
 24 orifices FG

sistema de soportes

material: polistireno,
 color: marfil
 clasificación posible:
zócalo doble 5762:
 29 agujeros PM/CA +
 12 agujeros FG
zócalo cuadruple 5764:
 62 agujeros PM/CA +
 24 agujeros FG



5762



33 x 66 x 58 mm



5764



66 x 66 x 58 mm

Polierpaste

Diamant (3µ), 5ml
 Hochglanz für Metalle,
 Keramik und Komposit
 (Sparsame Anwendung)

polishing paste

Diamant (3µ), 5ml
 high-lustre for metals,
 ceramics and composites
 (economical application)

pâte à polir

Diamant (3µ), 5ml
 brillant pour métaux,
 céramiques et composites
 (application économique)

pasta de pulir

Diamant (3µ), 5ml
 alto brillo para metales,
 cerámica y composites
 (utilización económica)



9646



**EVERCLEAR
Mundspiegel**

Bleiben nach kurzem
Anwärmen längere Zeit klar
Höchste Reflektion
Desinfizierbar, sterilisierbar

**EVERCLEAR
mouth mirrors**

stay clear longer if shortly
warmed
maximum reflection
disinfectable, sterilizable

**miroirs à bouche
EVERCLEAR**

après un court préchauf-
fage les miroirs restent plus
longtemps clair
réflexion maximale
peut être désinfecté et stérilisé

**espejos de boca
EVERCLEAR**

no se empañarán por buen
espacio de tiempo si se
calienten brevemente
reflexión máxima se puede
desinfectar y esterilizar



plan
plain
plat
plano

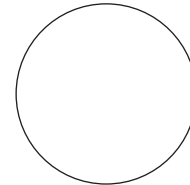
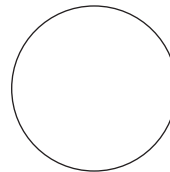
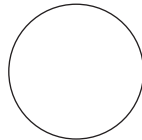

442



Ø mm	2 18	4 22	5 24
------	---------	---------	---------



hohl
concave
concave
cóncavo

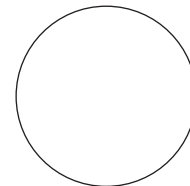
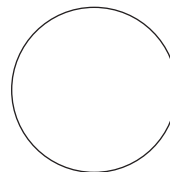

443



Ø mm		4 22	5 24
------	--	---------	---------

Präzisions-Bohrerlehre

Stahl, matt verchromt

precision bur gauge

steel, matt chrome-plated

filière

acier, chromé mat

calibrador de fresas

acero, cromado mate

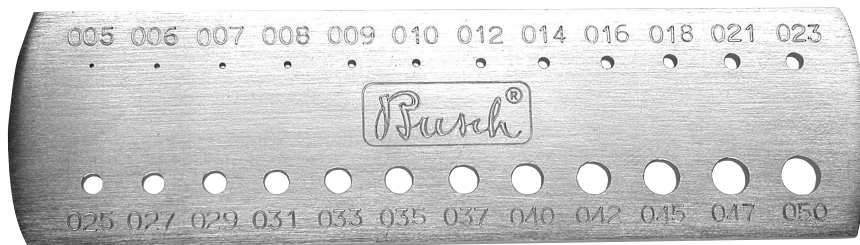

5099



107,7 x 29,55 x 1,94 mm

Sonstiges • Keramik Block, Reinigungsstein, Abrichtdiamant
 Miscellaneous • ceramic block, dressing stone, dressing diamond
 Autres • bloque céramique, pierre à débourrer, diamant à dresser
 Otros • bloque de cerámica, piedra de limpieza, recortador diamantado



Keramik Block

zum Abrichten und Abziehen von Polierern und Schleifkörpern

groß, grün, feine und mittlere Körnung
 large, green, fine and medium grit
 grand, vert, taille de grain fin et moyen
 grande, verde, grano fino y medio

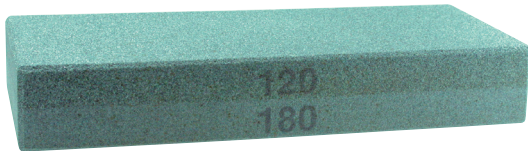

440



120 x 50 x 20 mm

ceramic block

for dressing of polishers and abrasives

bloque céramique

pour dresser et rectifier les polissoirs et abrasifs

bloque de cerámica

para recortar y afilar pulidores y abrasivos

klein, hellblau, grobe Körnung
 small, light blue, coarse grit
 petit, bleu clair, taille de grain gros
 pequeño, azul claro, grano grueso



441



20 x 33 x 4 mm

Reinigungsstein

vor der Anwendung anfeuchten
 Entfernen von festhaftenden Partikeln an Diamantschleifer bei einer Drehzahl von 1.000 - 5.000 min⁻¹

dressing stone

dampen before use for the removal of particles sticking to diamond instruments at an instrument speed of 1.000-5.000 rpm.

pierre à débourrer

mouiller avant l'utilisation pour enlever les particules adhérentes aux instruments diamantés, en travaillant à une vitesse entre 1.000 et 5.000 tours/min⁻¹.

piedra de limpieza

mojar antes de la utilización para eliminar partículas pegadas en los instrumentos diamantados, trabajando con una velocidad de 1.000-5.000 revoluciones/minuto



599



100 x 25 x 14 mm

Abrichtdiamant

dressing diamond

diamant à dresser

recortador diamantado

990



120 x 12 x 6 mm

Abziehen= Reinigen von zugesetzten Schleifkörpern und Polierern/sharpening= cleaning of clogged abrasives and polishers/
 dresser= nettoyer des abrasifs et polissoirs encrassés/afilar= limpieza de abrasivos y pulidores

Abrichten= Formen von Schleifkörpern und Polierern/dressing= shaping of abrasives and polishers/
 rectifier= façonnage des abrasifs et polissoirs/recortar= dar forma/tallar abrasivos y pulidores

Stahl

steel

acier

acero

TOP Mandrel

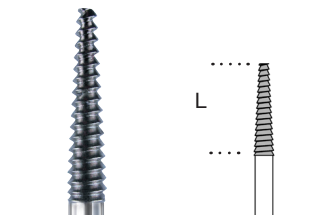
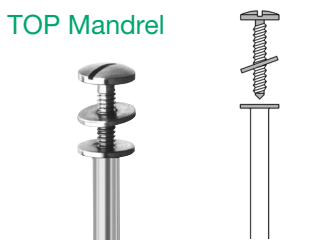

H/HP/PM ISO 300 104 ...	303/050 603 391 050
----------------------------	------------------------

H/HP/PM ISO 311 104 ...	329/027 610 417 027
L mm	12,00

Stahl, rostsicher (ISO 330)

steel, stainless (ISO 330)

acier, inoxydable (ISO 330)

acero, inoxidable (ISO 330)

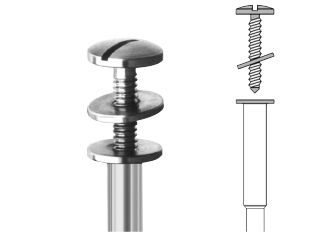
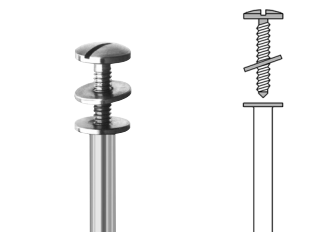

W/RA/CA ISO 330 204 ...	303RS/050 603 391 050
H/HP/PM ISO 330 104 ...	303RS/050 603 391 050

W/RA/CA ISO 330 204 ...	305RS/050 604 391 050
H/HP/PM ISO 330 104 ...	305RS/050 604 391 050

-	305RS/080 604 391 080
---	--------------------------

H/HP/PM ISO 330 104 ...	301L-RS/050 610 415 050
L mm	12,0

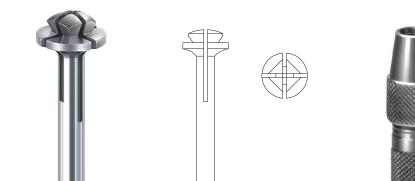
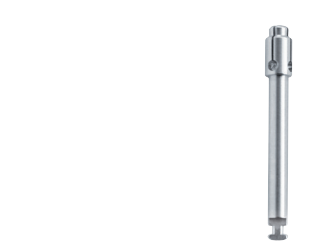
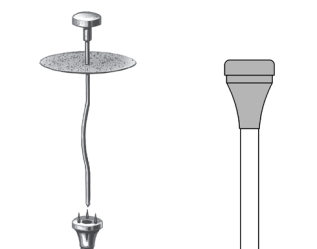

H/HP/PM ISO 330 104 ...	311RS 618 423 060
----------------------------	----------------------

W/RA/CA ISO 330 204 ...	312RS/016 204 608 016
----------------------------	--------------------------

W/RA/CA ISO 330 204 ...	313RS/060 615 421 060
H/HP/PM ISO 330 104 ...	313RS/060 615 421 060

H/HP/PM ISO 330 104 ...	324RS/030 612 432 030
----------------------------	--------------------------

Papierstreifenträger

sandpaper strip mandrel

porte-bande papier

portacinta papel

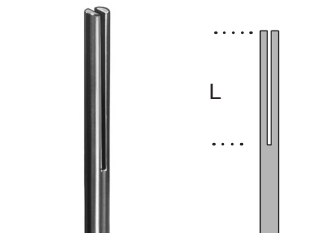
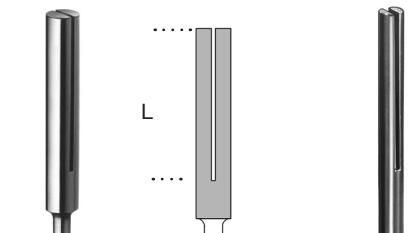
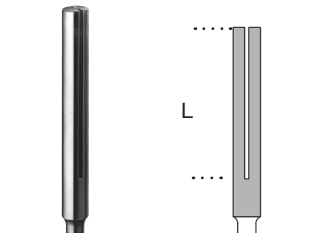
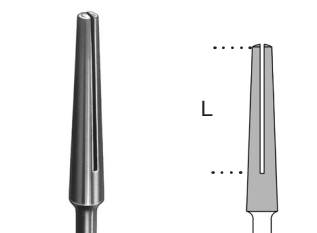

H/HP/PM ISO 330 104 ...	314RS/040 622 444 040
L mm	17,00

H/HP/PM ISO 330 104 ...	315RS/035 623 444 035
L mm	20,00

H/HP/PM ISO 330 104 ...	316RS/045 623 444 035
L mm	20,00

H/HP/PM ISO 330 104 ...	318RS/023 623 443 023
L mm	15,00

Basisinformationen

Basic information • Informations de base • Información básica



Pictogramme Pictographs Pictographies Pictogramas	104
Schafdaten, Produktetikett Data of shanks Product label Donnés de tiges, Étiquette du produit Datos de los mangos, Etiquetas de los productos	105
Technische Daten Technical data Données techniques Datos técnicos	106+107
Drehzahlempfehlungen Recommended r.p.m. Recommandations de Recomendaciones de	108+109
Diamant Körnung Diamond grit Diamantés grain Diamantados grano	110
ZIRAMANT Körnung ZIRAMANT grit Grain ZIRAMANT Grano ZIRAMANT	111
Sicherheits-, Gebrauchs- und Hygiene-Empfehlungen Safety, usage and hygiene recommendations Recommandations de sécurité, d'utilisation et d'hygiène Recomendaciones de seguridad, uso e higiene	112-115



Symbole/symbols/symboles/signos

	Ultraschallbad ultrasonic bath bain à ultrasons bano de ultrasonido		Kunststofftechnik acrylic technique technique acrylique técnica de plásticos para prótesis		Sicherheits- und Hygiene-Empfehlungen nach Medizinprodukte-Richtlinie 93/42/EWG, Anhang I, 13.1 + 13.2 safety and hygienic recommendations according to the medical device directive 93/42/ EEC, annex I, 13.1 + 13.2 recommandations de sécurité et d'hygiène selon la directive européenne 93/42/CEE aux dispositifs médicaux, annexe I, 13.1 + 13.2 recomendaciones de seguridad e higiene según la directiva 93/42/CEE relativa a productos medicinales, anexo I, 13.1 + 13.2
	Reinigungs-/Desinfektionsgerät für die thermische Desinfektion washer-disinfector for thermal disinfection laveur désinfecteur pour désinfection thermique aparato limpiador de desinfección para la desinfección térmica		Wurzelglättung root planing surfaçage radiculaire alisamiento de raíces		Packungseinheit packing unit unité d'emballage cantidad de envase
	sterilisierbar im Dampfsterilisator (Autoklav) bei der angegebenen Temp. sterilizable in a steam sterilizer (autoclave) at the temperature specified stérilisable dans le stérilisateur à vapeur d'eau (autoclave) à la température spécifiée esterilización en el esterilizador de vapor (autoclave) a temperaturas especificadas		Kieferorthopädie orthodontics orthodontie ortodoncia		Hersteller manufacturer fabricant fabricante
	sterilisierbar im Heißluftsterilisator bei der angegebenen Temperatur sterilizable in a dry heat sterilizer operating at the temperature specified stérilisable à la chaleur sèche à la température spécifiée esterilizar en el esterilizador de aire caliente a las temperaturas especificadas		Kronen- und Brückentechnik crown and bridge technique technique de couronnes et bridges técnica de coronas y puentes		Fertigungslos-Nummer, Charge lot number/batch number numéro de lot número de lote de producción
	Chemiklav chemiclave chemiclave chemiclave		Modellherstellung model fabrication fabrication de modèles fabricación de modelos		Referenznummer, Artikelnummer reference number numéro de référence número de referencia
	Desinfektionsmittel für Handinstrumente und rotierende Instrumente disinfectant for hand-held and rotary instruments désinfectant pour instruments dentaires à main et rotatifs medios de desinfección para instrumentos de mano y instrumentos rotativos		Modellgusstechnik model casting technique technique de squelette técnica de colado de metal		Gebrauchsanweisung beachten consult instructions for use consulter le manuel d'utilisation consultar las instrucciones de uso
	Kavitätenpräparation cavity preparation préparation cavitaire preparación de cavidades		Wurzelkanalaufbereitung root canal preparation traitement endodontique tratamiento endodóntico		Maximale zulässige Drehzahl [min⁻¹] Maximum permitted rotation speed [min ⁻¹] Vitesse de rotation admissible max [min ⁻¹] Velocidad de rotación máxima admisible [min ⁻¹]
	Kronenpräparation crown preparation préparation coronaire preparación coronaria		Bearbeiten von Zirkonoxid working on zirconia traitement de l'oxyde de zirconium elaboración del óxido de zirconio		
	Füllungsbearbeitung working on fillings préparation des obturations preparación de obturaciones		Verblend-/Keramiktechnik veneer and ceramic technique technique de revêtement et céramique técnica de revestimiento y cerámica		
			Prophylaxe prophylaxis prophylaxie profilaxia		
			Nicht zur Wiederverwendung do not reuse ne pas réutiliser no reutilizable		
			Diamantdurchsetzte Polierer diamond interspersed polishers polissoirs diamantés pulidores diamantados		



Sicherheits- und Hygiene-Empfehlungen nach Medizinprodukte-Richtlinie 93/42/EWG, Anhang I, 13.1 + 13.2

safety and hygienic recommendations according to the Medical Device Directive 93/42/ EEC, annex I, 13.1 + 13.2

recommandations de sécurité et d'hygiène selon la Directive Européenne 93/42/CEE aux dispositifs médicaux, annexe I, 13.1 + 13.2

recomendaciones de seguridad e higiene según la directiva 93/42/CEE relativa a productos medicinales, anexo I, 13.1 + 13.2

Schaftdaten/data of shanks/donnés des tiges/datos de los mangos

Arten/types/types/tipos	∅		ISO
FG 	1,60 mm	19 mm	314
FG lg 	1,60 mm	21 mm	315
FG x-lg 	1,60 mm	25 mm	316
W/RA/CA/CA 	2,35 mm	22 mm	204
H/HP/PM/PM 	2,35 mm	44,5 mm	104
unmontiert unmounted non-monté sin montar 	mit Bohrung/ with hole/ avec alésage/ con perforación 1,7 mm/1,8 mm	–	900

Konstruktionsbedingte Längenabweichungen vorbehalten/constructional length differences reserved/divergences de longueur conditionnées par la fabrication sont réservées/divergencias de la longitud por razones de fabricación reservadas

Produktetikett/product label/étiquette de produit/etiquetas de los productos



a
b
c
d
e
f
g
h
i
j
k



Wir versehen jede unserer Verpackungen mit einem ausführlichen Produkt-Etikett:

- a+b HIBC-Code
- c Busch Artikel-Nr.
- d+e Angaben des Busch-Partners
- f Hinweis auf weitere Infos in BUSCH-Katalogen; homepage
- g CE-Zeichen für Medizinprodukte
- h LOT-Nummer
- i die maximal zulässige Umdrehungszahl;
- j die Material- und Schaftbezeichnung
- k die Busch-Nr. und Größe

Zu Ihrer Information und Sicherheit.

We provide each of our packagings with a detailed product label:

- a+b HIBC-Code
- c Busch reference
- d+e details about the BUSCH-partner
- f advice on further information in BUSCH-catalogues; homepage
- g CE-mark for medical products
- h LOT-number
- i max. admissible rpm
- j material-and shank description
- k Busch-number and size

For your information and safety.

Sur chacun de nos emballages se trouve une étiquette détaillée:

- a+b le code HIBC
- c Busch référence
- d+e informations du distributeur BUSCH
- f indications pour plus d'informations dans les catalogues BUSCH; site d'Internet
- g sigle CE pour produits médicaux
- h numéro du lot
- i la vitesse de rotation max. admissible
- j désignation du matériel et de la tige
- k figure et taille BUSCH

Pour votre information et votre sécurité.

En cada caja mencionamos los datos siguientes:

- a+b código HIBC
- c referencia Busch
- d+e datos del distribuidor de BUSCH
- f indicaciones para mayor información en nuestros catálogos; pagina web
- g la marca CE para productos médicos
- h No. LOT
- i No. de revoluciones máximas admisibles
- j tipo de material y del mango
- k código de BUSCH y tamaño

Para su información y su seguridad.



Diamant/diamond/diamant/diamante

Diamant Synthetisches blockiges Korn oder Naturkorn in anwendungsspezifischer Größe	diamond synthetic block-like grits or natural grit in a size suitable for specific applications	diamant grains synthétiques ou grains naturels aux dimensions spécifiques en fonction des applications.	diamante granos sintéticos o granos naturales en dimensiones adecuadas para las aplicaciones
Schaftmaterial Rostsicherer Stahl	material of shank stainless steel	matériau de la tige acier inoxydable	material del mango Acero inoxidable
Bindungsaufbau Dämpfungsschicht Bindschicht Hart- und Glanzschicht	bonding structure damping layer bonding layer hard and brilliance layer	structure de l'adhésion couche d'amortissement couche de liage couche dure et brillante	estructura de unión capa de amortiguación capa de fijación capa dura y de brillo
Schaft-Durchmesser FG 1,6 mm (ISO 314) FG lg 1,6 mm (ISO 315) FG-xlg 1,6 mm (ISO 316) W 2,35 mm (ISO 204) H 2,35 mm (ISO 104)	Shank diameter FG 1,6 mm (ISO 314) FG lg 1,6 mm (ISO 315) FG-x-long 1,6 mm (ISO 316) RA 2,35 mm (ISO 204) HP 2,35 mm (ISO 104)	diamètre de la tige FG 1,6 mm (ISO 314) FG lg 1,6 mm (ISO 315) FG-x-longue 1,6 mm (ISO 316) CA 2,35 mm (ISO 204) PM 2,35 mm (ISO 104)	diámetro del mango FG 1,6 mm (ISO 314) FG lg 1,6 mm (ISO 315) FG-x-largo 1,6 mm (ISO 316) CA 2,35 mm (ISO 204) PM 2,35 mm (ISO 104)
Arbeitsteil-Durchmesser 0,7-30 mm	working part diameter 0,7-30 mm	diamètre de la partie travaillante 0,7-30 mm	diámetro de la parte de fresado 0,7-30 mm
Rundlaufgenauigkeit Besser als Normen	exact concentricity Superior to standards	concentricité supérieure aux normes	concentricidad Superior a las normas
Normen DIN, EN, ISO	standards DIN, EN, ISO	normes DIN, EN, ISO	normas DIN, EN, ISO
Max. zul. Umdrehungszahl Auf jeder Packung angegeben	maximum admissible speed Indicated on each package	vitesse maximale admissible indiquée sur chaque boîte	velocidad máxima admitida de revolución indicada en cada cajita

Polierer, Bürsten, Schwabbel und Träger/polishers, brushes, polishing buffs and mandrels/ polissoirs, brosses, disques à polir mandrins/pulidores, cepillos, discos de trapos mandriles

Material Polierer Silikon, Polyurethan (PUR), Polyester	material polishers silicone, polyurethan (PUR), polyester	matériaux polisseurs silicone, polyuréthane (PUR), polyester	material pulidores silicona, poliuretano (PUR), poliéster
Material Bürsten Zahnmedizin: Polyamid Zahntechnik: Naturborsten	material brushes dentistry: polyamide dental technique: bristle	matériaux brosses odontologie: polyamide prothèse dentaire: poils naturels	material cepillos odontologia: poliamid protesis dental: cerdas naturales
Schwabbel Zahntechnik Cambric, Wildleder, Baumwolle, Microfaser	polishing buffs dental technique cambric, suède, cotton microfiber	disques à polir prothèse dentaire cambrai, suède, coton micro-fibre	discos pulidores protesis dental cambrayón, gamuza, algodón micro fibra
Träger hochwertiger Spezialstahl, rostsicher oder vernickelt	mandrels high-grade special steel, stainless or nickel plated	mandrins acier de qualité supérieure, inoxydable ou nickelage	mandriles acero especial de alta calidad, inoxidable o niquelado
Bindungshärte supersoft, soft, weich, mittel, hart	bond hardness super soft, soft, medium, hard	dureté de liaison super soft, soft, doux, moyen, dur	dureza de la ligazón muy suave, suave, blanda, media, dura
Schleifmittel Siliziumkarbit (SiC) Diamant Edelkorund (Al ₂ O ₃) Bims	abrading medium silicone carbide (SiC) diamond high grade corundum pumice	composites abrasifs carbure de silicium (SiC) diamant corindon affiné (Al ₂ O ₃) ponce	material abrasivo carburo de silicio (SiC) diamante corindón fino (Al ₂ O ₃) piedra pómez
Korngröße extra fein, fein, mittel, grob	grit size extra fine, fine, medium, coarse	taille de grain extra fin, fin, moyen, gros	tamaño de grano extra fino, fino, medio, grueso
Schaftmaterial rostsicherer Stahl oder vernickelt Kunststoff	shank material stainless steel or nickel-plated plastic	matériaux de la tige Acier inoxydable ou nickelage Matière plastique	material del mango Acero inoxidable o niquelado Plástico

Gesamtlängen, Schaft ISO	total length, shank ISO	longueur totale, tige ISO	longitud total, mango ISO
H 47,0 - 58,0 mm 104	HP 47,0 - 58,0 mm 104	PM 47,0 - 58,0 mm 104	PM 47,0 - 58,0 mm 104
W 22,0 - 31,0 mm 204	RA 22,0 - 31,0 mm 204	CA 22,0 - 31,0 mm 204	CA 22,0 - 31,0 mm 204
FG 21,0 - 25,0 mm 314	FG 21,0 - 25,0 mm 314	FG 21,0 - 25,0 mm 314	FG 21,0 - 25,0 mm 314
Schaft-Durchmesser	shank diameter	diamètres des tiges	diámetro del mango
H 2,35 mm - 0,016 mm	HP 2,35 mm - 0,016 mm	PM 2,35 mm - 0,016 mm	PM 2,35 mm - 0,016 mm
W 2,35 mm - 0,016 mm	RA 2,35 mm - 0,016 mm	CA 2,35 mm - 0,016 mm	CA 2,35 mm - 0,016 mm
FG 1,60 mm - 0,010 mm	FG 1,60 mm - 0,010 mm	FG 1,60 mm - 0,010 mm	FG 1,60 mm - 0,010 mm
Arbeitsteil-Durchmesser	working part diameter	diamètres de la partie travaillante	diámetro de la parte de fresado
3,0 - 26,0 mm	3,0 - 22,0 mm	3,0 - 22,0 mm	3,0 - 22,0 mm
Die Angabe ISO Ø erfolgt in 1/10 mm.	the ISO diameter is mentioned in one 10th of a millimetre.	L'indication ISO Ø en 1/10 mm	El diámetro ISO Ø significa 1/10 mm.
Normen	standards	normes	normas
DIN, EN, ISO	DIN, EN, ISO	DIN, EN, ISO	DIN, EN, ISO
Max. zul. Umdrehungszahl	max. admissible speed	vitesse maximum admise	velocidad máxima admisible
auf jeder Packung angegeben	mentioned on each package	indiquée sur chaque boîte	indicada en cada cajita

Schleifkörper/abrasives/abrasifs/abrasivos

Schleifmittel	abrasive	produits abrasifs	material abrasivo
Siliziumkarbid (SiC)	silicon carbide (SiC)	carbure de silicium (SiC)	carburo de silicio (SiC)
Edelkorund (Al ₂ O ₃)	high-grade corundum (Al ₂ O ₃)	corindon affiné (Al ₂ O ₃)	corindón fino (Al ₂ O ₃)
Diamant	diamond	diamant	diamante
Korngröße	grit size	taille de grain	tamaño de grano
extra fein, fein, mittel, grob	extra fine, fine, medium, coarse	extra fin, fin, moyen, gros	extra fino, fino, medio, grueso
Bindungsart	bonding	liaison	ligazón
Keramisch, Magnesit, Kunstharz	ceramic, magnesite, resin	céramique, magnésite, résine	Cerámica, magnesita, resina
synthetisch	synthetic	synthétique	synthetica
Bindungshärte	bonding hardness	dureté de liaison	dureza de la ligazón
weich, mittel, hart, extra-hart	soft, medium, hard x-hard	doux, moyen, dur extra dur	blanda, media, dura extra dura
Formgebung	shaping	façonnage	dar forma
Pressen, Schleifen	pressing, grinding	presser, meuler	presionar, amolar
Schaftmaterial	material of shanks	matériau des tiges	material del mango
rostsicherer Stahl	stainless steel	acier inoxydable	Acero inoxidable
Gesamtlängen	total length	longueur totale	longitud total
H 44,3 - 51,0 mm	HP 44,3 - 51,0 mm	PM 44,3 - 51,0 mm	PM 44,3 - 51,0 mm
W 22,7 - 29,5 mm	RA 22,7 - 29,5 mm	CA 22,7 - 29,5 mm	CA 22,7 - 29,5 mm
FG 21,0 - 25,0 mm	FG 21,0 - 25,0 mm	FG 21,0 - 25,0 mm	FG 21,0 - 25,0 mm
Schaft-Durchmesser	shank diameter	diamètres des tiges	diámetro del mango
H 2,35 - 0,016 mm	HP 2,35 - 0,016 mm	PM 2,35 - 0,016 mm	PM 2,35 - 0,016 mm
W 2,35 - 0,016 mm	RA 2,35 - 0,016 mm	CA 2,35 - 0,016 mm	CA 2,35 - 0,016 mm
FG 1,60 - 0,010 mm	FG 1,60 - 0,010 mm	FG 1,60 - 0,010 mm	FG 1,60 - 0,010 mm
Arbeitsteil-Durchmesser	working part diameter	diamètres de la partie travaillante	diámetro de la parte de fresado
1,8 - 75,0 mm	1,8 - 75,0 mm	1,8 - 75,0 mm	1,8 - 75,0 mm
Die Angabe ISO Ø erfolgt in 1/10 mm.	The ISO diameter is mentioned in one 10th of a millimetre.	l'indication ISO Ø en 1/10 mm	el diámetro ISO Ø significa 1/10 mm.
Normen	standards	normes	normas
DIN, EN, ISO	DIN, EN, ISO	DIN, EN, ISO	DIN, EN, ISO
Max. zul. Umdrehungszahl	max. admissible speed	vitesse maximum admise	velocidad máxima admisible
auf jeder Packung angegeben	mentioned on each package	indiquée sur chaque boîte	indicada en cada cajita



Zahnmedizin/dentistry/odontologie/odontología

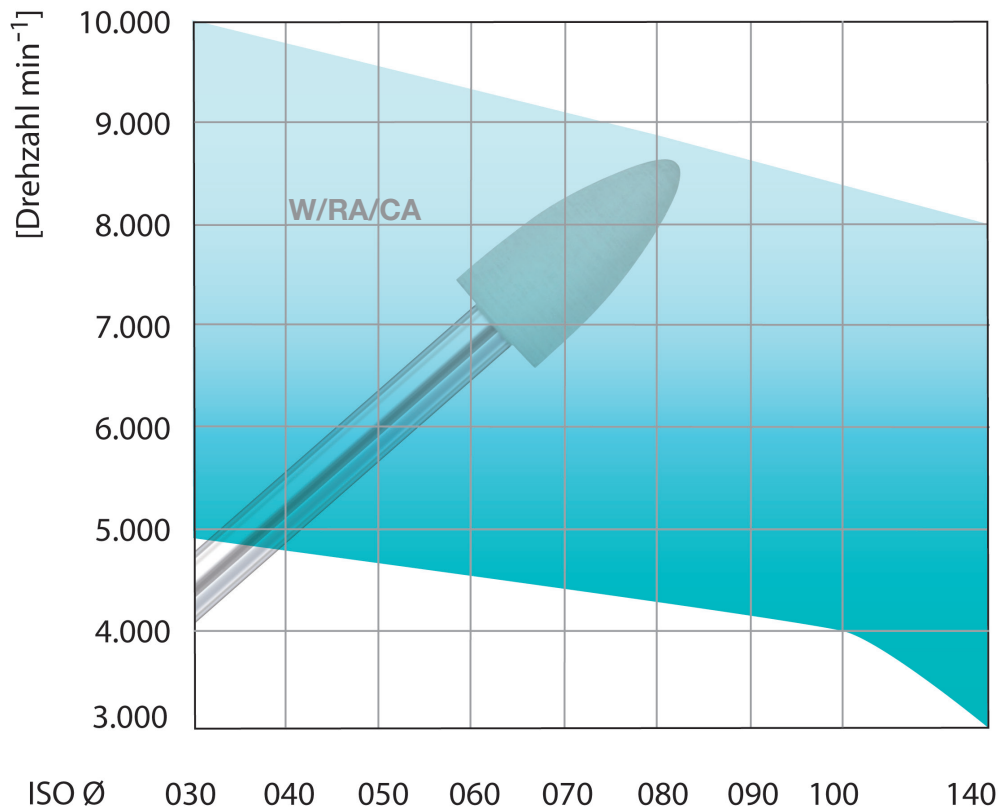

(FG Ø030: 3.000–8.000 min⁻¹)
 mit Wasserkühlung.
 Bei unzureichender Wasserkühlung kann es zu irreversiblen Schädigungen des Zahnes und des umliegenden Gewebes kommen.

(FG Ø030: 3.000–8.000 min⁻¹)
 with water spray.
 If not sufficient cooling medium is used, irreversible damages of the teeth and the surrounding tissue can happen.

(FG Ø030: 3.000–8.000 min⁻¹)
 avec refroidissement à l'eau.
 En cas d'un refroidissement à l'eau insuffisant les dents ainsi que les gencives peuvent être nuits d'une façon irréversible.

(FG Ø030: 3.000–8.000 min⁻¹)
 con refrigeración del espray (agua).
 En caso de refrigeración con agua insuficiente podría causar daños irreversibles en los dientes y alrededor del tejido/encia.

Zahntechnik/dental technique/prothèse dentaire/protesis dental

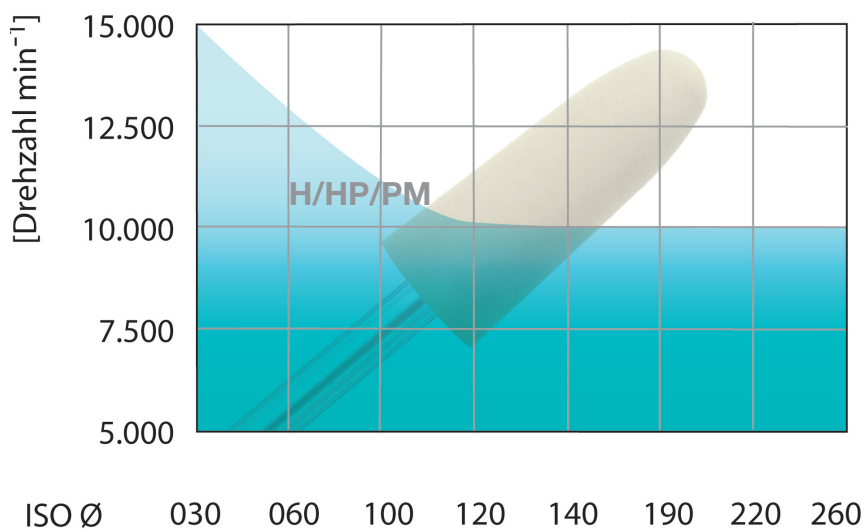

Zahnmedizin/dentistry/odontologie/odontología

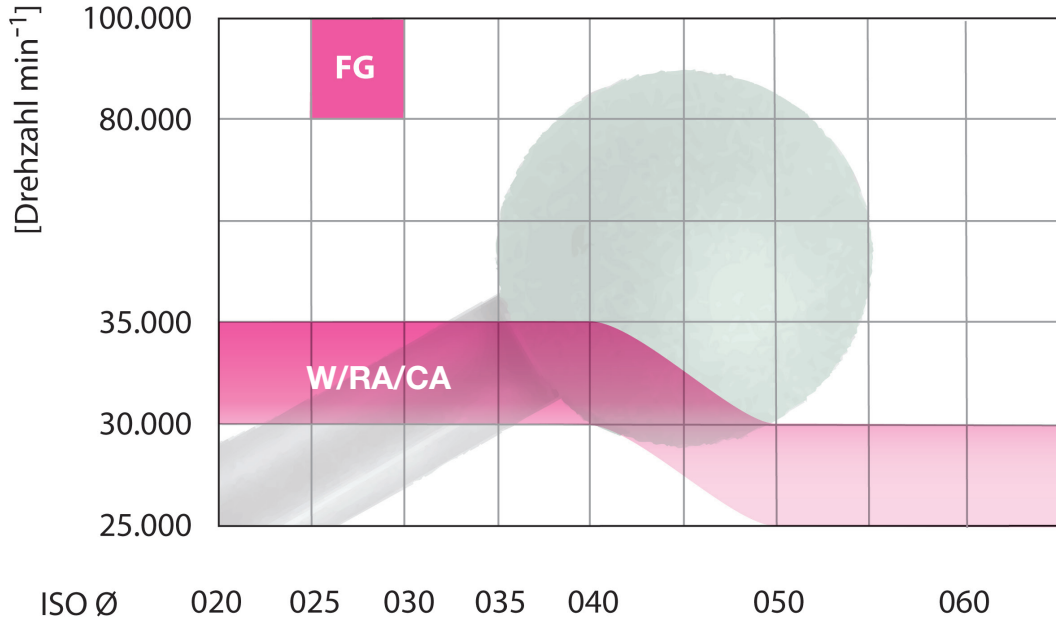

Zahntechnik/dental technique/prothèse dentaire/protesis dental

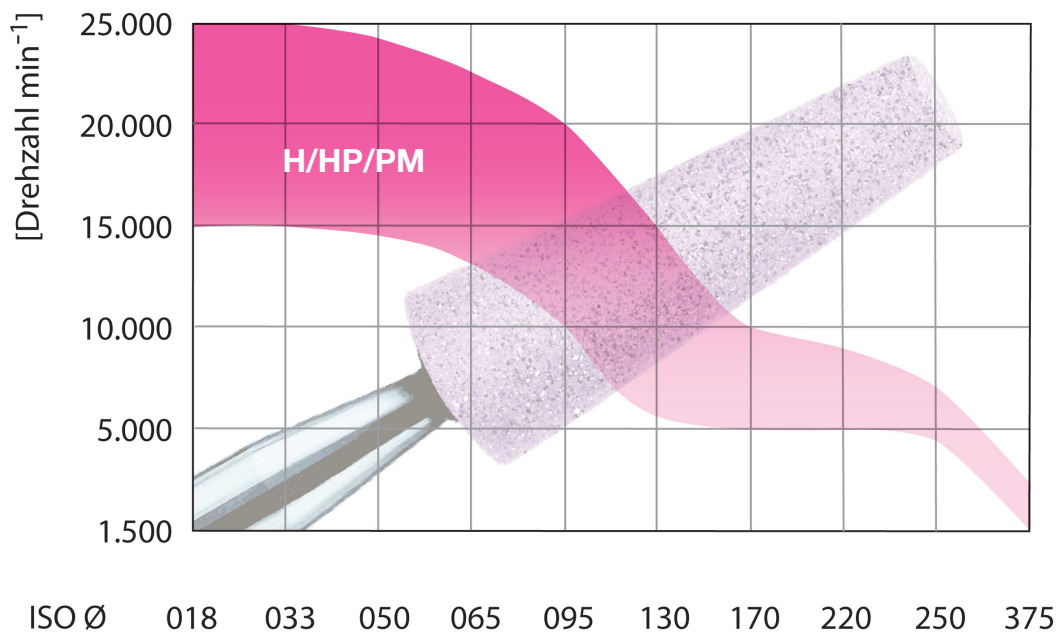





Diamantdurchsetzte Schleifkörper
 diamond interspersed abrasives
 abrasifs entremêlés des diamants
 abrasivos entremezclados con diamantes

040-120: 8.000-12.000 min⁻¹
 040-120: 8.000-12.000 r.p.m.
 040-120: 8.000-12.000 min⁻¹
 040-120: 8.000-12.000 min⁻¹



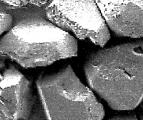

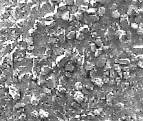
siehe Seite 74
 see page 74
 voir page 74
 vease página 74

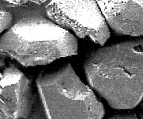
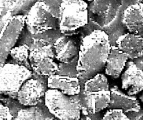

Diamant Körnung Zahnmedizin/diamond grit dentistry/diamantés grain odontologie/diamantados grano odontologia

Körnung grit grain grano	R.E.M. (30x) D.S.M. (30x) M.E.B. (30x) M.E.R. (30x)	*) Korngröße (µm), Mittelwert *) grit size (µm), mean value *) taille de grain (µm), valeur moyenne *) tamaño de grano (µm), valor medio	ISO-Nr. ISO-No. ISO-No. ISO-No.	Farbkennzeichnung color code code couleurs marcado de colores	Anwendung application application aplicación
sehr grob very coarse très gros muy grueso		181	544	schwarzer Ring ● black ring bague noire anillo negro	zügiges Vorschleifen quick pregrinding dégrossissage rapide tallado inicial rápido
grob coarse gros grueso		151	534	grüner Ring ● green ring bague verte anillo verde	Vorschleifen pregrinding dégrossissage tallado inicial
mittel medium moyen medio		107	524	ohne Ring without ring sans bague sin anillo	Formschleifen shape grinding façonnage rectificado de forma
fein fine fin fino		46	514	roter Ring ● red ring bague rouge anillo rojo	Feinschleifen fine grinding abrasion de précision rectificado fino
extra fein extra fine extra fin extra fino		25	504	gelber Ring ● yellow ring bague jaune anillo amarillo	Finieren finishing finition acabado

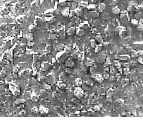
Diamant Körnung Zahntechnik/diamond grit dental technique/diamantés grain prothèse dentaire/
diamantados grano protesis dental



Körnung grit grain grano	R.E.M. (30x) D.S.M. (30x) M.E.B. (30x) M.E.R. (30x)	*) Korngröße (µm), Mittelwert *) grit size (µm), mean value *) taille de grain (µm), valeur moyenne *) tamaño de grano (µm), valor medio	ISO-Nr. ISO-No. ISO-No. ISO-No.	Farbkennzeichnung color code code couleurs marcado de colores	Anwendung application application aplicación
mega grob mega coarse mega gros hiper grueso		500	-	2 schwarze Ringe ●● 2 black rings 2 bagues noire 2 anillos negros	zügiges Vorschleifen quick pregrinding dégrossissage rapide rectificado inicial rápido
super grob super coarse super gros super grueso		300	-	schwarzer Ring ● black ring bague noire anillo negro	Vorschleifen pregrinding dégrossissage rectificado inicial
grob coarse gros grueso		151	534	grüner Ring ● green ring bague verte anillo verde	Vorschleifen pregrinding dégrossissage rectificado inicial
mittel medium moyen medio		107	524	ohne Ring without ring sans bague sin anillo	Formschleifen shape grinding façonnage rectificado de forma
fein fine fin fino		46	514	roter Ring ● red ring bague rouge anillo rojo	Feinschleifen fine grinding abrasion de précision rectificado fino
extra fein extra fine extra fin extra fino		25	504	gelber Ring ● yellow ring bague jaune anillo amarillo	Finieren finishing finition acabado

ZIRAMANT Körnung zur Bearbeitung von Zirkonoxid in der Zahnmedizin

ZIRAMANT grit for work on zirconia in dentistry

Grain ZIRAMANT pour le traitement de l'oxyde de zirconium dans l'ontologie

Grano ZIRAMANT para el tratamiento de circonio (ZrO₂) en la odontología

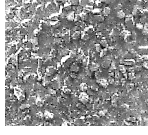
Körnung grit grain grano	R.E.M. (30x) D.S.M. (30x) M.E.B. (30x) M.E.R. (30x)	*) Korngröße (µm), Mittelwert *) grit size (µm), mean value *) taille de grain (µm), valeur moyenne *) tamaño de grano (µm), valor medio	ISO-Nr. ISO-No. ISO-No.	Farbkennzeichnung color code code couleurs marcado de colores	Anwendung application application aplicación
grob coarse gros grueso		91 – 151	535	2 Ringe ● ● 1 blauer + 1 grüner 2 rings 1 blue + 1 green 2 bagues 1 bleue + 1 verte 2 anillos 1 azul + 1 verde	Trepanieren, Entfernen von Zirkonoxid trepaning removal of zirconium oxide trépanation, retrait de l'oxyde de zirconium trépanación, eliminación del óxido de circonio
mittel medium moyen medio		91 – 126	525	2 blaue Ringe ● ● 2 blue rings 2 bagues bleues 2 anillos azules	Korrektur von Zirkonoxid corrections of zirconium oxide correction de l'oxyde de zirconium retoque del óxido de circonio
fein fine fin fino		40 – 60	515	2 rote Ringe ● ● 2 red rings 2 bagues rouges 2 anillos rojos	Feinkorrektur von Zirkonoxid fine corrections of zirconium oxide correction de précision de l'oxyde de zirconium retoques precisos del óxido de circonio

ZIRAMANT Körnung zur Bearbeitung von Zirkonoxid in der Zahntechnik mit Laborturbine

ZIRAMANT grit for work on zirconia in dental technique with laboratory turbine

Grain ZIRAMANT pour le traitement de l'oxyde de zirconium avec turbine laboratoire pour les prothèses dentaires

Grano ZIRAMANT para el tratamiento de óxido de circonio con la turbina de uso en laboratorios dentales

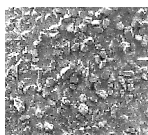
Körnung grit grain grano	R.E.M. (30x) D.S.M. (30x) M.E.B. (30x) M.E.R. (30x)	*) Korngröße (µm), Mittelwert *) grit size (µm), mean value *) taille de grain (µm), valeur moyenne *) tamaño de grano (µm), valor medio	ISO-Nr. ISO-No. ISO-No.	Farbkennzeichnung color code code couleurs marcado de colores	Anwendung application application aplicación
grob coarse gros grueso		107 – 151	535	2 Ringe ● ● 1 grüner + 1 schwarzer 2 rings 1 green + 1 black 2 bagues 1 verte + 1 noire 2 anillos 1 verde + 1 negro	Punktförmiges, flächiges Ausschleifen grinding individual points and larger areas abrasion ponctuelle et de surfaces lisado en punta y bidimensional
fein fine fin fino		40 – 60	515	2 rote Ringe ● ● 2 red rings 2 bagues rouges 2 anillos rojos	Feinstbearbeitung von Zirkonoxid finest work on zirconium oxide traitement de précision de l'oxyde de zirconium tratamientos precisos de óxido de circonio

*) Die Korngröße ist optimal abgestimmt auf übliche Anwendungsgebiete, Umdrehungszahlen, Formen und Größen der Diamantschleifer und kann im Mittelwert bei einzelnen Instrumenten abweichen.

*) Most favourable grit size for the usual applications, speed and as well as for sizes and shapes of the diamond instruments may differ from the mean value of individual instruments.

*) La taille de grain est adaptée de façon optimale aux différentes applications, vitesses de rotation, formes et diamètres des instruments diamantés, et peut différer de la moyenne dans le cas de certains instruments.

*) El tamaño de grano está adaptado, de manera óptima, a las aplicaciones, velocidades, formas y diámetros de los instrumentos diamantados y su valor medio puede diferir en algunos instrumentos en particular.



Sicherheitsempfehlungen

- Bis zum erstmaligen Einsatz sollte die Aufbewahrung rotierender Instrumente in der Originalverpackung bei Zimmertemperatur staub- und feuchtigkeitsgeschützt erfolgen.
- Zur eventuellen Rückverfolgung die Verpackung auch während der Nutzungsphase aufbewahren.
- Einwandfreie, gewartete und gereinigte Turbinen-, sowie Hand- und Winkelstück-Antriebe einsetzen.
- Instrumente so tief wie möglich einspannen; Festsitz prüfen.
- Atem-/ Augenschutz und Absaugung beachten.
- Instrumente vor dem Ansetzen an das Objekt auf Drehzahl bringen; dabei auf exakten Rundlauf achten.

- Maximal zulässige Umdrehungszahl beachten (auf jeder BUSCH-Packung angegeben. Überhitzungs-/Verletzungsgefahr)
- Verkanten und Hebeln der Instrumente vermeiden.
- Andruckkraft 0,3 bis 2 N nicht überschreiten (Bruchgefahr sowie Gefahr iatrogenen Verletzungen im Arbeitsbereich sowie Gefahr heterotroper Ossifikation nach Überhitzung/Verbrennung).
- Instrumente nur entsprechend ihrer Zweckbestimmung einsetzen.
- Das Nicht-Beachten oder Vernachlässigen der nachstehend aufgeführten Hygieneempfehlungen kann zur Übertragung von Krankheitserregern führen.
- Möglichst die gesamte Arbeitsteillänge nutzen, um punktuelle Überbelastung z.B. der Spitzen (mechanische Überbeanspruchung und lokale Überhitzung) zu vermeiden.

- Zur Vermeidung unerwünschter Wärmeentwicklung (Überhitzung) ist für eine ausreichende Wasserkühlung zu sorgen. In der zahnärztlichen Praxis mindestens 50 ml in der Minute vorsehen.
- Bei FG-Instrumenten mit einer Gesamtlänge von mehr als 22 mm oder einem Kopfdurchmesser größer als 2 mm kann zusätzliche Kühlung erforderlich sein.
- Bei chirurgischen Instrumenten mit langem Schaft ist ggf. eine zusätzliche Kühlung erforderlich.
- Verbogene bzw. nicht rundlaufende Instrumente oder Instrumente mit beschädigten/abgenutzten Arbeitsteilen müssen zur Vermeidung von Verletzungen oder Überhitzung durch Reibung stumpfer Instrumente aussortiert und entsorgt werden.

Hygieneempfehlungen

1 Vorbereitung 2 Reinigung 3 Sterilisation 4 Thermische Desinfektion

Anwendungsbereich: Rotierende Stahl-, Hartmetall-, Keramik- und Diamantinstrumente, Polierer, Schleifkörper und Bürsten zur Anwendung am Menschen. Die Instrumente werden im unsterilen Zustand ausgeliefert. Sie müssen vor dem Ersteinsatz und nach jeder Nutzung desinfiziert, gereinigt und desinfiziert oder ggf. sterilisiert werden. Aus hygienischen und technischen Gründen müssen Schleifklappen und Schleifkappenträger unmontiert desinfiziert und sterilisiert werden.

Einschränkung der Wiederaufbereitung: Prophylaxe-Bürsten sind Einmalprodukte, da eine rückstandslose Reinigung nicht gewährleistet werden kann. Bei nicht rostischen Instrumenten sind Desinfektions- und Reinigungsmittel mit Korrosionsschutz zu verwenden. **Nicht rostische Instrumente sind nicht für den Dampfsterilisator geeignet.** Die Produktlebensdauer wird von Verschleiß und Beschädigung durch den Gebrauch der Instrumente bestimmt - eine genaue Angabe über die Anzahl von Wiederaufbereitungen kann daher nicht gegeben werden. Niemals Wasserstoffperoxid H₂O₂ zur Instrumentendesinfektion verwenden - Materialschäden sind ggf. nicht auszuschließen!

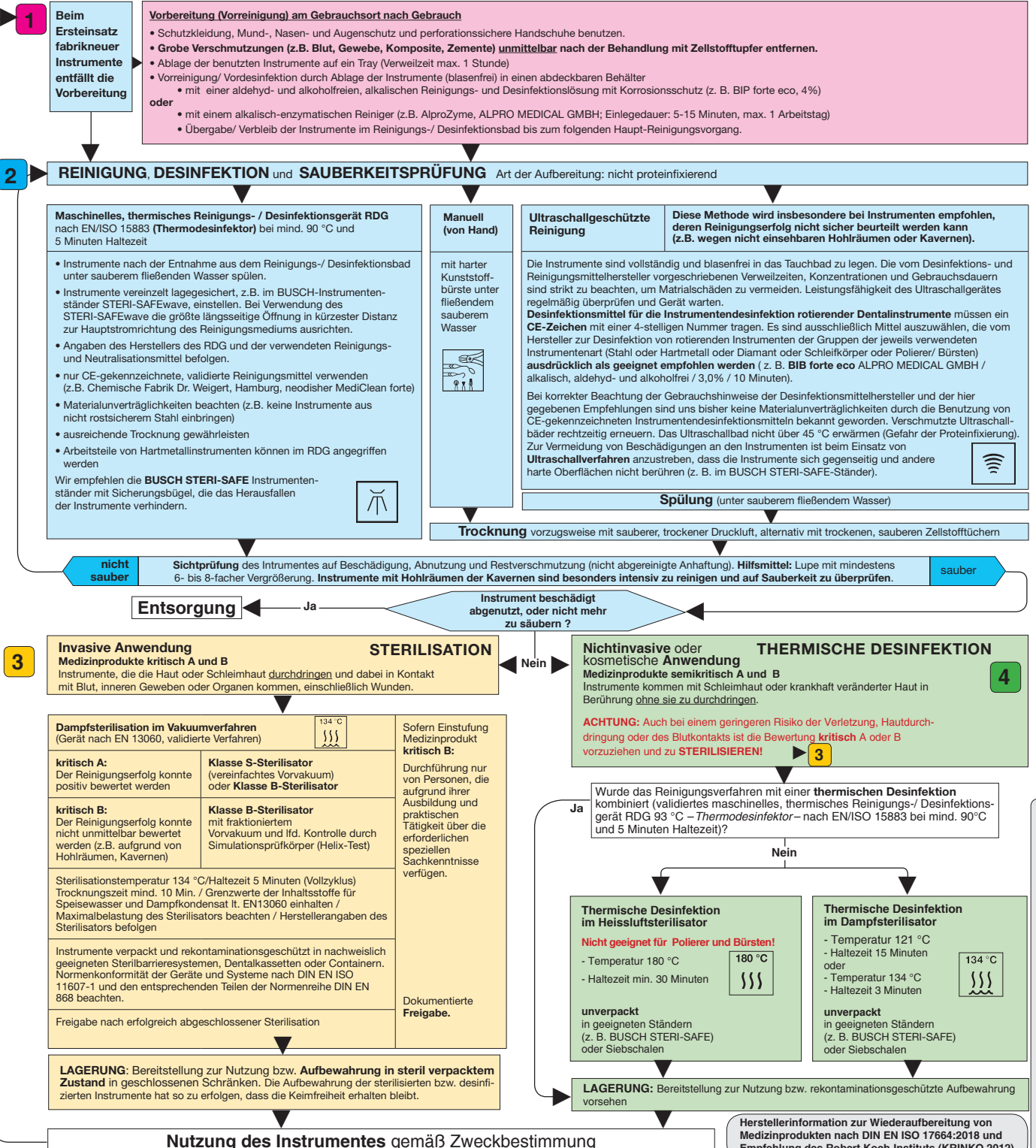

Safety recommendations

- Until they are first used, rotating instruments should be kept in their original packaging, and protected from dust and moisture, at room temperature.
- Always keep the packaging (also during the active usage period) so that the instruments are traceable if required.
- Always use fully functioning, correctly serviced and maintained as well as cleaned turbine drives as well as hand-held and angle-piece drives.
- Insert the instruments as deeply as possible. Check for firm seating.
- Use respiratory and/or eye protection and an extraction system.
- Before starting to work on the workpiece, bring the instruments up to operating speed and make sure that they are running concentrically.
- Observe the maximum speed (as indicated on all BUSCH packaging). Risk of overheating and injury.
- Make sure that the instruments don't get jammed or levered.
- Do not exceed a contact pressure of 0.3 to 2.0 N. (Risk of breakage and iatrogenic injuries in the working space and danger of heterotropic ossification after overheating/burning.)
- Only use the instruments in accordance with their intended use
- Failure to comply with or adhere to the following hygiene recommendations can lead to transmission of pathogens.
- If possible, use the entire length of the working part in order to avoid point overheating, e.g. of the tips (resulting excessive mechanical stress and local overheating).
- Make sure that there is sufficient water cooling to avoid unwanted heat development (overheating). For the dental practice, this means a minimum cooling flow of 50 ml per minute ensure a minimum.
- FG instruments with a total length of more than 22 mm or a head diameter more than 2 mm might require additional cooling.
- Surgical instruments with a long shaft might require additional cooling.
- Bent or non-concentrically running instruments or instruments with damaged or worn working parts must be rejected and disposed of in order to avoid injury or overheating through friction caused by blunt instruments.

Hygiene recommendations

1 Preparation 2 Cleaning 3 Sterilisation 4 Thermal disinfection

Area of application: Rotating instruments made of steel, carbide, ceramic or diamond as well as polishers, abrasive tools and brushes that are intended for the application on humans. The instruments are delivered non-sterile. Before they are used for the first time as well as after each use, they must be disinfected or cleaned and disinfected or, if required, sterilised. Grinding caps and cap mandrels have to be disinfected and sterilized unmounted for hygienic and technical reasons.

Restrictions for the processing of re-sterilisable instruments: Brushes for prophylaxis are single-use products because it cannot be guaranteed that the brushes can be cleaned entirely free from residue. For non-rust-free instruments, disinfectants and cleaning agents with corrosion protection must be used. **Non-rust-free instruments are not suitable for steam sterilisation.** The product service life is determined by wear and damage caused by the instruments' use. Therefore, specific details regarding the number of processing runs cannot be provided. Never use hydrogen peroxide (H₂O₂) for disinfection of the instruments because the risk of damage to the material cannot be excluded.

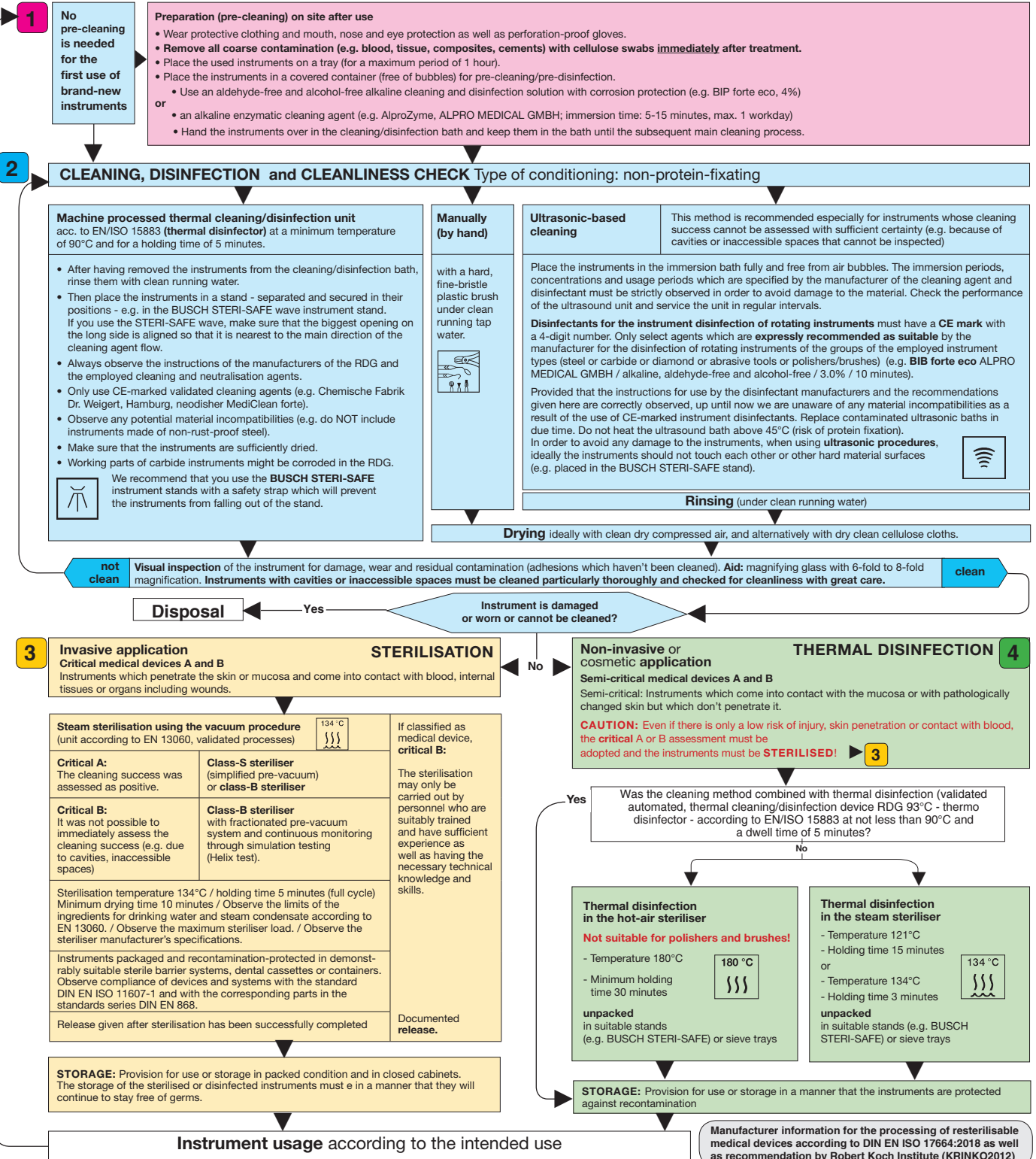

Recommandations de sécurité

- D'ici leur première utilisation, les instruments rotatifs devraient être conservés dans leur emballage d'origine, à température ambiante et à l'abri de la poussière et de l'humidité.
- Conserver l'emballage pour un éventuel suivi, également pendant la phase d'utilisation.
- Utiliser des turbines ainsi que des pièces à main et contre-angles en parfait état, entretenus et nettoyés.
- Fixer les instruments en les insérant le plus profondément possible; contrôler la bonne tenue.
- Utiliser une protection respiratoire des yeux et un système d'aspiration
- Amener les instruments à la bonne vitesse de rotation avant de les mettre en contact avec l'objet; veiller à leur concentricité exacte.

- Ne pas dépasser la vitesse maximale admissible (elle est indiquée sur chaque emballage BUSCH). Risque de surchauffe/blessure.
- Éviter tout mouvement de blocage et de levier des instruments.
- Ne pas dépasser une pression de contact de 0,3 à 2 N. (risque de bris et risque de blessures iatrogènes dans la zone de travail ainsi que risque d'ossification hétérotrophe après une surchauffe/combustion).
- N'utiliser les instruments qu'aux fins auxquelles ils sont destinés.
- La non-observation ou l'observation insuffisante des recommandations d'hygiène indiquées ci-après peut entraîner la transmission d'agents pathogènes.
- Utiliser si possible la longueur totale de la partie travaillante pour éviter un surcharge ponctuelle des pointes par exemple (contrainte mécanique excessive et surchauffe locale).

- Un refroidissement suffisant à l'eau est requis pour éviter un dégagement de chaleur indésirable (surchauffe). Dans les cabinets dentaires, prévoir au moins 50 ml à la minute.
- Les instruments FG dont la longueur totale dépasse 22 mm ou qui possèdent une tête d'un diamètre supérieur à 2 mm requièrent un refroidissement supplémentaire.
- Un refroidissement supplémentaire peut être nécessaire pour les instruments chirurgicaux à tige longue.
- Ne pas utiliser les instruments déformés ou à concentricité insuffisante ainsi que ceux avec des parties travaillantes endommagées/usées mais les éliminer pour éviter des blessures ou une surchauffe due au frottement d'instruments émoussés.

Recommandations d'hygiène

1 Préparation 2 Nettoyage 3 Stérilisation 4 Désinfection thermique

Champ d'application: instruments rotatifs en acier, carbure, céramique et diamants, instruments de polissage, abrasifs et brosses destinés à un usage sur l'être humain. Les instruments sont livrés à l'état non stérile. Ils doivent être désinfectés, nettoyés et, le cas échéant, désinfectés ou stérilisés avant de les utiliser pour la première fois et après chaque utilisation. Pour des raisons hygiéniques et techniques démonter les capuchons abrasifs et leurs supports lors de la désinfection et de la stérilisation. **Restriction de retraitement:** les brosses prophylactiques sont des instruments à usage unique, car un nettoyage sans résidus ne peut pas être garanti. Des désinfectants et des détergents contenant un agent de protection contre la corrosion doivent être employés pour les instruments non inoxydables. **Les instruments non inoxydables ne sont pas appropriés à une stérilisation à la vapeur.** La durée de vie du produit dépend de l'usure et de l'endommagement liés à l'utilisation des instruments. Il n'est donc pas possible de fournir des indications précises sur le nombre de retraitements. N'utiliser en aucun cas de l'eau oxygénée (H₂O₂) pour la désinfection des instruments. Des endommagements de matériaux ne peuvent être exclus!

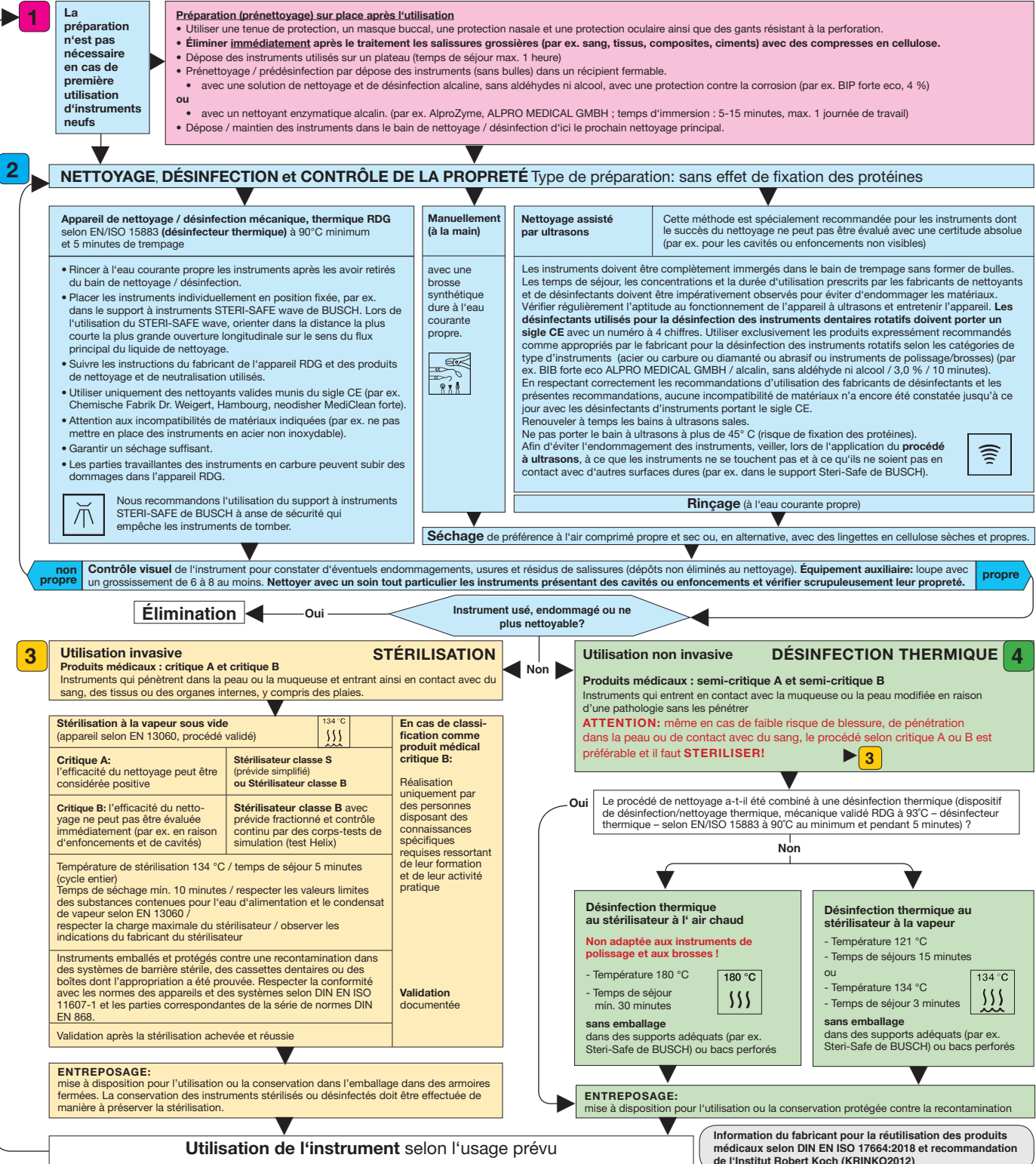

Recomendaciones de seguridad

- Hasta el momento del primer uso, los instrumentos rotativos deben ser conservados en el envase original, a temperatura ambiente y protegidos del polvo y de la humedad.
- Conservar el envase para una trazabilidad eventual, incluso durante la fase de uso.
- Utilizar turbinas y piezas de mano, en perfecto estado, mantenidos y limpiados.
- Fijar los instrumentos introduciéndolos lo más profundamente posible. Comprobar que están bien fijados.
- No sobrepasar el número máximo de revoluciones (se halla indicada encada envase BUSCH). Riesgo de sobrecalentamiento/lesiones.
- Evitar ladear y apalancar los instrumentos.
- Dependiendo de la aplicación, utilizar mascarilla/protección ocular y aspiración.
- No superar una presión de contacto de 0,3 a 2 N. (Riesgo de rotura, riesgo de lesiones iatrogénicas en la zona de trabajo y riesgo de osificación heterotrofa después del sobrecalentamiento/quemadura).
- Utilizar los instrumentos solo conforme al uso previsto.
- La no observancia o el descuido de las siguientes recomendaciones de higiene pueden ocasionar el contagio de gérmenes patógenos.
- A ser posible usar la longitud de la parte activa completa para evitar una posible sobrecarga, p. ej. de los extremos (desgaste mecánico y sobrecalentamiento local).
- Para evitar que se produzca un calentamiento no deseado hay que procurar un enfriamiento suficiente con agua (sobrecalentamiento). En la práctica odontológica es como mínimo de 50 ml por minuto.
- Los instrumentos FG con una longitud total superior a 22 mm, o un diámetro del cabezal superior a 2 mm, requieren un enfriamiento adicional.
- En los instrumentos quirúrgicos con mango largo puede resultar necesario un enfriamiento adicional.
- Se deben desechar y eliminar los instrumentos deformados o que no giren de forma concéntrica, así como los que tengan las partes activas dañadas o desgastadas para evitar lesiones o sobrecalentamientos debidos a la fricción de instrumentos sin filo.

Recomendaciones de higiene

1 Preparación 2 Limpieza 3 Esterilización 4 Desinfección térmica

Campo de aplicación: instrumentos rotativos de acero, carburo, cerámica, pulidores, abrasivos, cepillos tal como instrumentos diamandados para aplicaciones al cuerpo humano. Los instrumentos se entregan en estado no estéril. Por razones higiénicas y técnicas, los capuchones y sus soportes deben esterilizarse y desinfectarse desmontados. Antes de la primera utilización y después de cada uso deben ser desinfectados, limpiados y desinfectados o, dado el caso, esterilizados.

Limitación de la reutilización: los cepillos profilácticos son productos de un solo uso, puesto que no se puede garantizar una limpieza sin dejar restos. En el caso de instrumentos no inoxidable se han de emplear productos desinfectantes y limpiadores con protección anticorrosiva. **Los instrumentos no inoxidables no son aptos para el esterilizador a vapor.** La vida útil del producto está determinada por el desgaste y deterioro causados por el uso de los instrumentos. Por este motivo no se puede indicar un número exacto de reutilizaciones. No utilizar nunca agua oxigenada (H₂O₂) para la desinfección de instrumentos. ¡No se descarta que se produzcan eventualmente daños en el material!

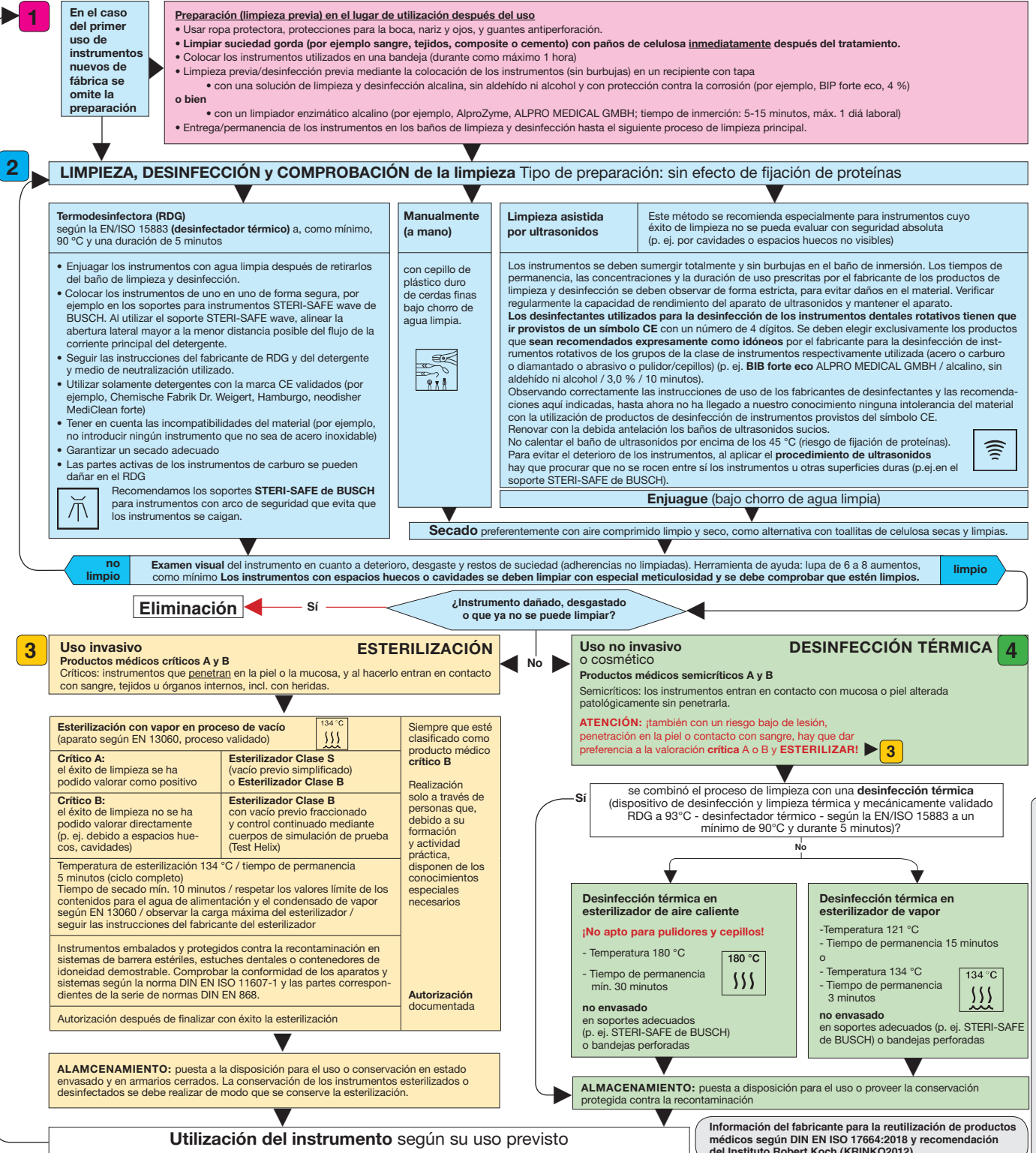

ZAHNMEDIZIN
DENTISTRY
ODONTOLOGIE
ODONTOLOGIA

Diamant

COOL DIAMANT

CD03	9
CD06	9
CD09	9
CD12	9
CD15	9
CD18/CD18G	9
CD19/CD19G	9
CD21/CD21G	11
CD24/CD24G	11
CD25/CD25G	11
CD27/CD27G	11
CD30/CD30G	11
CD33/CD33G/CD33F	11
CD34/CD34G	11
CD36	12
CD37	12
CD39/CD39G	12
CD42/CD42G	12
CD45	12
CD48/CD48G	12
CD51/CD51G	12
CD54/CD54G	13
CD55/CD55G/CD55F	13
CD57	13
CD60/CD60G/CD60F	13
CD61/CD61G/CD61F	13
CD63	10
CD66/CD66G/CD66F	10
CD69/CD69G/CD69F	10
CD72/CD72G/CD72F	10
CD78/CD78G	13
CD80/CD80G/CD80F	13

sehr grobe Körnung

very coarse grit
 grain très gros
 grano muy grueso

5368	29
5379	29
5801	15
5811	29
5831	16
5836	18
5837	18
5848	24
5850	26
5856	26
5862	28
5863	28
5878	19
5878K	25
5879	19
5879K	25
5881	21
5909	31

grobe Körnung

coarse grit
 grain gros
 grano grueso

6368	29
6379	29
6801	15
6801L	15
6802	15
6805	16

6806	16
6830	16
6831	16
6831R	16
6835	18
6836KR	17
6836	18
6837KR	17
6837	18
6838	21
6846	24
6847	24
6847KR	22
6848	24
6848KR	22
6850	26
6852	27
6855	26
6856	26
6858	27
6859	27
6862	28
6863	28
6878	19
6878K	25
6879	19
6879K	25
6880	21
6881	21
6882	21
6889	29
6909	31

mittlere Körnung
 medium grit
 grain moyen
 grano mediano

368	29
379	29
390	29
801	15
801L	15
802	15
805	16
806	16
807	16
811	29
813	31
818	31
830	16
831	16
831R	16
833A	31
834	31
835	18
835KR	17
836	18
836KR	17
837	18
837L	18
837LKR	17
837KR	17
838	21
839	30
842	18
842KR	17
845	24
845KR	22
846	22
846KR	22
CI846	23
847	24
CI847	23
847KR	22
848	24

848KR	22
850	26
851	30
852	27
855	26
856	26
857	30
858	27
859	27
860	28
861	28
862	28
863	28
864	28
876	19
877	19
877K	25
878	19
878K	25
879	19
879K	25
879L	19
880	21
881	21
882	21
885	20
886	20
899	29
908	31
909	31
MI 801	33
MI 802	33
MI 806	33
MI 830	33
MI 838	33
MI 889	33

feine Körnung

fine grit
 grain fins
 grano fino

8801	15
8368	29
8390	29
8379	29
8390	29
8392	30
8801	15
8830	16
8831	16
8831R	16
8835	18
8835KR	17
8836	18
8836KR	17
8837	18
8837LKR	17
8837KR	17
8838	21
8845	24
8845KR	22
8846	24
8846KR	22
8847	24
8847KR	22
8848	24
8848KR	22
8849	26
8850	26
8852	27
8855	26
8856	26
8858	27
8859	27
8860	28

8861	28
8862	28
8863	28
8863GK	30
8864	28
8876	19
8877	19
8877K	25
8878	19
8878K	25
8879	19
8879L	19
8879K	25
8880	21
8881	21
8882	21
8886	20
8889	29
8899	29
8406LF	35
8407LF	35
MI 8802	33
MI 8806	33
MI 8830	33
MI 8838	33
MI 8889	33

x-fein Körnung

x-fine grit
 grain x-fin
 grano x-fino

368EF	29
379EF	29
390EF	29
801EF	15
835KREF	17
836KREF	17
837KREF	17
845KREF	22
846KREF	22
CI846EF	23
CI847EF	23
847KREF	22
852EF	27
856EF	26
858EF	27
859EF	27
860EF	28
862EF	28
863EF	28
863GKEF	30
878EF	19
879EF	19
881EF	21
957EF	30
8406LEF	35
8407LEF	35

ZIRAMANT

379Z	34
855Z	34
862Z	34
6801Z	34
6831RZ	34
6855Z	34
6880Z	34
8801LZ	34
8838LZ	34

Polierer/Bürsten WST

Polishers/Brushes RA
Polissoirs/Brosses CA
Pulidores/Cepillos CA

9577	39
9578	39
9579	39
9581	39
9587	39
9588	39
9589	39
9591	39
9604	41
9607	41
9608	41
9609	41
9607G	38
9608G	38
9609G	38
9611	41
9617	41
9618	41
9619	41
9621	41
9630	46
9631	46
9633M	46
9633S	46
9633SS	46
9635	47
9635H	47
9635S	47
9650	46
9667	40
9668	40
9669	40
9677	40
9678	40
9679	40
9730	47
9730H	47
9730S	47
9731	47
9731H	47
9731S	47
9735SiC	44
9730SiC	44
9731SiC	44
9807	42
9808	42
9809	42
9811	42
9817	42
9818	42
9819	42
9821	42
9907	43
9908	43
9909	43
9911	43
9917	43
9918	43
9919	43
9921	43

Soft Disc

9590G	45
9590M	45
9590F	45
9590EF	45
312RS	45
9590/100 Set	45
9590/140 Set	45

Schleifkörper WST

Abrasives RA
Abrasive CA
Abrasivos CA

grün/green/vert/verde	
601	50
602	50
603	50
619	50
622	50
624	50
626	50
627	50
637	50
648	50
649	50
661	50
662	50
666	50
667	50
671	50

Arkansas

weiss/white/blanc/blanco

601	51
638	51
649	51
653	51
661	51

**ZAHNTECHNIK
DENTAL TECHNIQUE
PROTHESE DENTAIRE
PROTESIS DENTAL**

Diamant

mega grobe Körnung	
mega coarse grit	
grain mega gros	
grano hiper grueso	
DT4854R	56
DT4880	56
super grobe Körnung	
super coarse grit	
grain extra gros	
grano super grueso	
5369	62
5405	63
DT5854R	56
DT5880	56
5893	63
5894	63
grobe Körnung	
coarse grit	
grain gros	
grano grueso	
6850	60
6854	59
6854R	59
6862	61
6863	61
6893	63
6894	63

mittlere Körnung	
medium grit	
grain moyen	
grano mediano	
368	61
369	62
390	61
801	57
805	57
807	57
812	62
818	62
825	62
830	62
835	57
836	57
837	58
842	58
842R	58
845	58
846	58
847	59
848	59
849	60
850	60
852	60
854	59
854R	59
855	60
856	60
858	60
859	61
860	61
862	61
863	61
880	58
893	63
894	63
909	62

feine Körnung	
fine grit	
grain fin	
grano fino	
8368	61
8390	61
8850	60
8854	59
8854R	59
8858	60
8859	61
8860	61
8863	61
8893	63
8894	63

x-fein Körnung	
x-fine grit	
grain x-fin	
grano x-fino	
368EF	61
390EF	61
850EF	60
858EF	60
863EF	61
893EF	61

**Diamantscheiben
Diamond Discs
Disques diamantés
Discos diamantados**

902	67
910	67
911	67

911H	66
911HH	66
911S	67
911PS	67
916	67
918PB	67
919P	67
943	66
7911	66
7912	66

**LONGLIFE-
- Sinter Diamant-Schleifer
- Sintered Diam. Instruments
- Diamant dans la masse
- Instrumentos diamantados**

1351	68
1837	68
1842R	68
1847	68
1850	68
1856	68
1881	68
1893	69
1941	69
3351	68
3368	69
3801	69
3818	69
3850	68
3856	68
3859	69
3862	69

ZIRAMANT

6379Z	64
6801LZ	64
6838LZ	64
6855Z	64
6860Z	64
8379Z	65
8838LZ	65
8855Z	65
8860Z	65

**Polierer
Polishers
Polissoirs
Pulidores**

9602	73
9603	73
9605	73
9602G	72
9603G	72
9612	73
9613	73
9615	73
9622	78
9624	78
9626	78
9628	78
9626G	78
9628G	78
9660	72
9690G	75
9690M	75
9702	73
9704	73
9706	73
9702G	72
9706G	72
9712	73
9716	73
9852	77

ZAHNTECHNIK
DENTAL TECHNIQUE
PROTHESE DENTAIRE
PROTESIS DENTAL

9853 77
 9854 77
 9862 77
 9863 77
 9864 77
 9952 76
 9953 76
 9954 76
 9962 76
 9963 76
 9964 76

Bürsten, Schwabbel
 Brushes, polishing buffs
 Broses, Disques à polir
 Cepillos, Discos pulidores

9544M 79
 9544F 79
 9636 81
 9638 81
 9641 80
 9642 80
 9643 80
 9644 80
 9736 81
 9738 81

Schleifkörper
 Abrasives
 Abrasifs
 Abrasivos

 **Diamantdurchsetzte**
 Diamond interspersed
 entremêlé des diamants
 entremezclado
 con diamantes

D712 74+84
 D733 74+84
 D732 74+84

grün/green/vert/verde
 601 84
 602 84
 609 84
 613 84
 622 84
 628 84
 632 84
 633 84
 637 85
 639 85
 649 85
 651 85
 661 85
 662 85
 663 85
 665 85
 667 85
 671 85
 731 85
 732 85
 733 85
 734 85
 743 85
 744 85

763 90
 773 90
 798 90
 CP613 84
 CP649R 84
 CP652R 84
 CP671 84
 CP732 84
 CP728 84

rosa/pink/rose/rosa
 601 86
 602 86
 603 86
 609 86
 613 86
 619 86
 620 86
 621 86
 623 86
 624 86
 627 86
 631 86
 632 86
 633 86
 636 86
 637 86
 638 86
 639 86
 640 86
 646 86
 648 86
 649 86
 650 86
 651 86
 652 86
 656 86
 657 86
 658 86
 661 86
 662 86
 663 86
 665 86
 666 86
 667 86
 671 86
 677 86
 682 86
 701 86
 702 86
 703 86
 711 86
 712 86
 716 86
 721 87
 722 87
 731 87
 732 87
 733 87
 743 87
 744 87
 749 87
 755 87
 759 87
 760 87
 767 91
 772 91
 777 91

weiss/white/blanc/blanco
 603 87
 607 87
 620 87
 737 87
 745 87

768 91
 778 91
 blau/blue/bleu/azul
 B601 85
 B649R 85
 B652R 85
 B671 85
 B732 85

Trennscheiben
 Separating discs
 Disques à separer
 Discos de separados
 grau/grey/gris/gris
 436 92
 braun/brown/marron/marrón
 435 92
 436 92
 437 92

Hitzlos Schleifräder
 Hitzlos abrasive wheels
 Hitzlos meules abrasives
 Hitzlos ruedas abrasivas
 761 88
 762 88
 766 88
 767 88
 771 88
 772 88
 773 88
 776 88
 777 88
 778 88
 782 88
 783 88

Silent Schleifräder
 Silent abrasive wheels
 Silent meules abrasives
 Silent ruedas abrasivas
 761 89
 762 89
 766 89
 767 89
 768 89
 771 89
 772 89
 773 89
 776 89
 777 89

Sonstiges
 Miscellaneous
 Drivers
 Otros
 440 100
 441 100
 442 99
 443 99
 599 100
 990 100
 5099 99
 5762 98
 5764 98
 STERI-SAFEpro 5772+D . . . 96
 STERI-SAFEwave 5773 . . . 97
 9646 98

Träger
 Mandrels
 Mandrins
 Mandriles
 303 101
 329 101
 301L-RS 101
 303RS 101
 305RS 101
 311RS 101
 312RS 101
 313RS 101
 314RS 101
 315RS 101
 316RS 101
 318RS 101
 324RS 101

Wichtige Hinweise:

- angemessene Auswahl von qualifizierten Reinigern/ Desinfektionsmittel unter besonderer Beachtung der Materialfreundlichkeit; kein Einsatz von Haushaltsreinigern; keine Säuren/ Laugen.

- konsequente Dosierung (keine Überdosierung) entsprechend den Herstellerangaben; Verdunstung bei mehrtägiger Verwendung von Reiniger-/Desinfektionsmittel-Bädern berücksichtigen (dabei verdunstet nicht nur das Wasser, die chemischen Inhaltsstoffe nehmen zu).

Fertiglösungen sind gegenüber Konzentraten vorzuziehen.

- Einhaltung der maximal zulässigen Verweilzeiten in Reinigern/Desinfektionsmitteln entsprechend der Herstellerangaben.

Bei Mißachtung droht Korrosion an den Instrumenten, die die Leistung, Stabilität und Oberflächenbeschaffenheit beeinträchtigen kann und ein vorzeitiges Aussondern erfordert.

Abbildungen und Fotos sind urheberrechtlich geschützt. Nachdruck oder Reproduktionen in irgendwelcher Form, auch auszugsweise, sind nur mit schriftlicher Genehmigung der BUSCH & CO. GmbH & Co. KG Engelskirchen, gestattet.

Programm- und Konstruktionsänderungen im Sinne des Fortschrittes sind Tradition des Hauses und bleiben vorbehalten.

Important information:

- Select appropriate qualified cleaners/ disinfectants giving special regard to material friendliness; do not use any household detergents; do not use acids or alkaline solutions

- Use consistent dosing (no overdose) according to the manufacturer's specifications; take evaporation into account when using cleaner/disinfectant baths for several days (not only water evaporates, the concentration of chemical ingredients will increase).

Ready-to-use solutions are preferable compared to concentrates.

- Comply with the maximum permissible dwell times in cleaners/disinfectants according to the manufacturer's specifications.

Failure to observe this warning may result in corrosion of the instruments, which will affect their performance, stability and surface texture requiring them to be discarded prematurely.

Illustrations and photos are protected by copyright. Reproductions, also by extract in any form, are only permitted with written authorization of BUSCH & CO. GmbH & Co. KG Engelskirchen.

To reserve the right to modify our range of products and their design in the sense of progress are traditions of our company.

Informations importantes:

- Choix adéquat de nettoyeurs/ désinfectants adaptés sous prise en considération particulière de la compatibilité avec les matériaux ; pas d'utilisation de nettoyeurs domestiques ; pas d'acides/ lessives.

- Dosage conséquent (pas de surdosage) selon les indications des fabricants ; tenir compte de l'évaporation lors d'une utilisation sur plusieurs jours des bains nettoyeurs/désinfectants (l'eau ne s'évapore ici pas seulement, les substances chimiques augmentent). **La préférence doit être donnée aux solutions prêtes à l'emploi plutôt qu'à des produits concentrés.**

- Respect des temps de séjour maximaux admissibles dans les nettoyeurs/ désinfectants conformément aux indications des fabricants.

Simon, les instruments pourraient se corroder, ce qui pourrait nuire aux performances, à la stabilité et à la finition et nécessiter une élimination prématurée.

Les illustrations et photos sont protégés par le droit de l'auteur. Toutes sortes de reproductions, même partielles sont seulement permises avec l'autorisation écrite de la société BUSCH & CO. GmbH & Co. KG Engelskirchen.

Nous nous réservons le droit aux modifications du programme et de la construction dans le sens du progrès qui sont la tradition de notre société.

Indicaciones importantes:

- Selección adecuada de productos de limpieza calificados o desinfectantes prestando especial atención a las características del material; no se pueden utilizar productos de limpieza domésticos; ácidos ni soluciones alcalinas.

- Dosificación coherente (sin sobredosis) de acuerdo con los datos del fabricante; tener en cuenta la evaporación en caso de utilizar durante varios días desinfectantes o productos de limpieza para baños (no solo se evapora el agua, sino que también aumentan las sustancias químicas).

Es preferible usar soluciones listas para su uso a concentrados.

- Cumplimiento de los tiempos de permanencia máximos permitidos en productos de limpieza o desinfectantes de acuerdo con las instrucciones del fabricante.

En caso de incumplimiento, los instrumentos pueden corroerse, cosa que puede afectar la eficacia, la estabilidad y el acabado profesional. Puede adelantar el apartamiento de la fresa.

Ilustraciones y fotografías protegidas por el derecho del autor. Reproducción también en extracto sólo se permite con la autorización escrita de la compañía BUSCH & CO. GmbH & Co. KG Engelskirchen.

Las variaciones que respeten el programa y el diseño en el sentido del progreso son tradición de nuestra empresa y quedan reservadas.



Unsere Premium Produkte aus Hartmetall, Keramik und Stahl finden Sie in diesem Katalog oder unter www.busch.eu

You can find our premium products made of carbide, ceramic and steel in this catalogue or under www.busch.eu

Vous trouverez nos produits premium en carbure, céramique et acier dans ce catalogue ou sous www.busch.eu

Encontrará nuestros productos premium de carburo, cerámica y acero en este catálogo o en www.busch.eu



BUSCH & CO. GmbH & Co. KG

Postfach 1152
D-51751 Engelskirchen

Unterkaltenbach 17-27
D-51766 Engelskirchen
GERMANY

Telefon: +49 (0) 2263 86-0
Telefax: +49 (0) 2263 20741
mail@busch.eu
www.busch.eu

